

DF-MA

Analog exit/IO-LINK position sensor for cylinders

- Continuous detection sensor of the piston rod's position, for direct mounting on cylinders with T-slot or tie rods with appropriate support brackets.
- Analog and IO-Link exit standard supplied
- Integrated button for regulation measurement range and selection of analog exit.

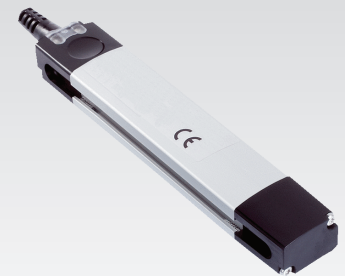

TECNICAL CHARACTERISTICS

Type	ANALOG/IO-Link
Part no.	DF-MA
Stroke measuring range (± 1 mm)	287÷1007 mm depending on the model
Voltage	15÷30 V DC
Type of connection	M8 male 4P
Sampling time	1,15 ms ^(C)
Resolution	0,03% FS ($\geq 0,06$ mm) ^(A)
Linearity	0,5 mm
Repeatability ^(B)	0,06% FSR ($\geq 0,1$ mm) ^(A)
Cylinder's traslation speed	< 3 m/s
Exit function	Analog: 0-10 V IO-Linnk : 4-20 mA
Overload protection	YES
Short circuit protection	YES
Reverse polarity protection	YES
Max load resistance (output current)	$\leq 500\Omega$
Min. load resistance (output voltage)	$\geq 2K\Omega$
Power consumption (without loading)	35 mA
Protection class	III
Protection degree	IP65 according EN 60529, IP67, IP68
Electromagnetic compatibility	according EN 60947-5-2
Shock and Vibrations	30 g, 11 ms / 10 ... 55 Hz, 1 mm
Ambient temperature	-20÷+70°C
Case material	plastic, cable: PUR

(A) FS: Full-scale (C) Only during the standard functioning no IO-Link

(B) T = 25 °C, 24 V DC

EXTENSION CABLES

M8 in-line connector 2 meters cable	DHF-P24M08
M8 in-line connector 5 meters cable	DHF-P54M08
M8 - 90° connector 2 meters cable	DHF-P24M0890
M8 - 90° connector 5 meters cable	DHF-P54M0890

CODIFICATION KEY

D	F	-	M	A	0	2	8	7	M	0	8
1			2					3			

1 Series	2 Measurement range	3 Connection
DF-MA = Magnetic position sensor	0287 = 287 mm 0539 = 539 mm 0791 = 791 mm 0323 = 323 mm 0575 = 575 mm 0827 = 827 mm 0359 = 359 mm 0611 = 611 mm 0863 = 863 mm 0395 = 395 mm 0647 = 647 mm 0899 = 899 mm 0431 = 431 mm 0683 = 683 mm 0935 = 935 mm 0467 = 467 mm 0719 = 719 mm 0971 = 971 mm 0503 = 503 mm 0755 = 755 mm 1007 = 1007 mm	M08 = M8 connector analog exit and IO-Link

Dimensions and electric connection

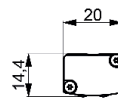
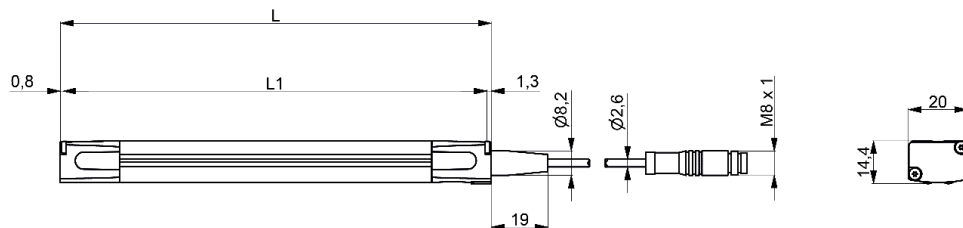

- ① Status indicator 1
- ② Status indicator 2
- ③ Control panel

L1 = Measurement range

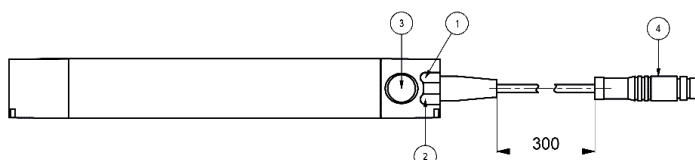

Part no.	Total length (L) (mm)	Measurement range (L1) (mm)
DF-MA0287M08	289	287
DF-MA0359M08	361	359
DF-MA0431M08	433	431
DF-MA0503M08	505	503

Electrical Circuit

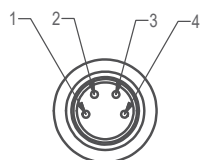

PIN	Color	Function
1	Brown	Supply port +
2	White	output current
3	Blue	Supply port -
4	Black	output current

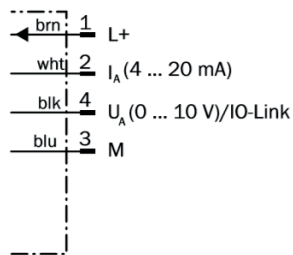

Output signal description

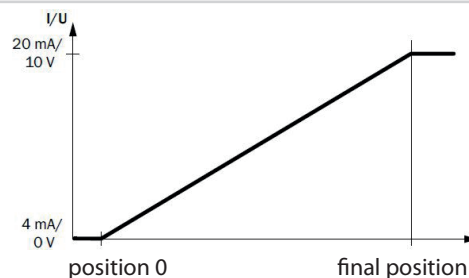

SAFETY SPECIFICATIONS

- Read the operating instructions before starting operation.
- Connection, assembly, and settings to be arranged only by competent technicians.
- No safety component in accordance with EU machine guidelines.
- Use power source according to IEC/DIN EN 60204-1.

PROPER USE

The DF-MA is a magnetic position sensor and is intended for linear path measurement on pneumatic actuators or with free position encoders. Avoid magnetically conductive components in close proximity of the DF-MA position sensor. A magnetic field strength between 2 mT and 15 mT is required in order to ensure a smooth function. Outside these limits, the specifications data cannot be guaranteed. Note the magnetic field indication. Magnetic field strength at optimum level: when the magnetic field is at its optimum level, LED 1 (yellow) is continuously on within the measuring range. Magnetic field strength not at optimum level: when the magnetic field is weak, LED 1 (yellow) is continuously on within the measuring range. In addition, LED 2 (red) is flashing. The measurement function and output are active, but the characteristic data may be outside specification. Ensure that the distance between the sensor and the magnet is between 4 mm and 8 mm, and that the distance remains constant. The piston position is recorded contact-free. The output of the measurement signal is made via an analogous voltage and current output or an IO link interface. The control panel allows the required measurement range to be precisely set. Setting the measuring range is not mandatory. The maximum possible measurement range is used as standard if you do not teach-in a measurement range. The Zero Point and End Point can be taught regardless the magnetic field polarity and the piston position.

MAINTENANCE

DF-MA magnetic position sensors are maintenance-free. We recommend that you should check the screw connections and plug-in connections regularly.

Mounting scheme

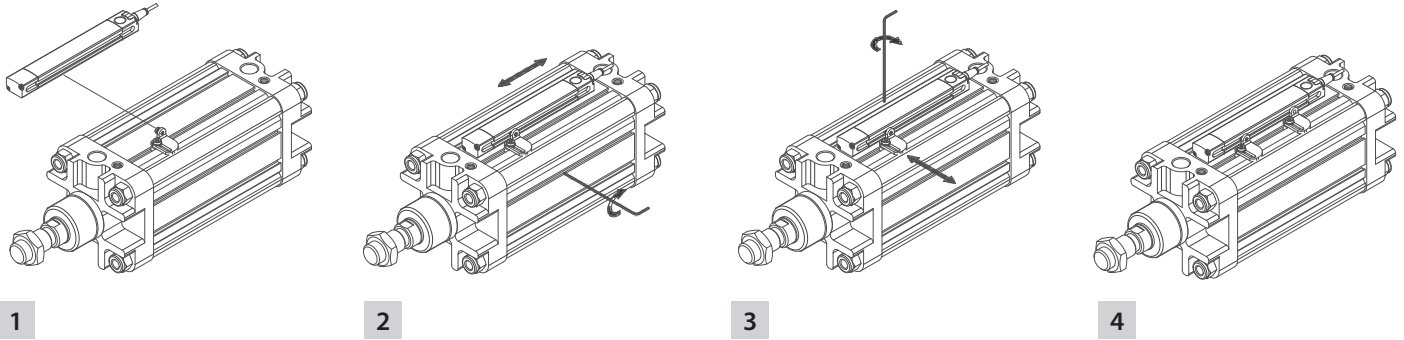

SENSOR ALIGNMENT AND FIXING

- 1 - Put the fixing bracket into one of the T-slots of the cylinder
- 2 - Insert the fixing bracket into the transducer groove
- 3 - Align the sensor so that it is placed in the center of the cylinder as much as possible
- 4 - If necessary install further fixing brackets and tight the screws based on the tightening torque shown in the user manual

M8 in-line connector with shielded cable

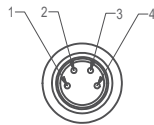
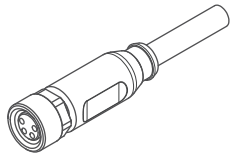

PIN	Color
1	Brown
2	White
3	Blue
4	Black

DHF-P24M08
M8 in-line connector 4 poles female with shielded cable
L = 2 m

DHF-P54M8
M8 in-line connector 4 poles female with shielded cable
L = 5 m

M8 - 90° connector with shielded cable

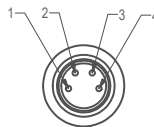
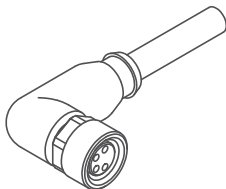

PIN	Color
1	Brown
2	White
3	Blue
4	Black

DHF-P24M0890
M8 90° connector 4 poles female with shielded cable
L = 2 m

DHF-P54M0890
M8 90° connector 4 poles female with shielded cable
L = 5 m

DF-004 Slot plate - vertical installation

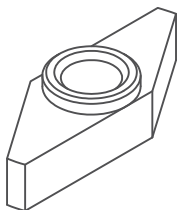

DF-MSS12TO Fixing bracket for T-slot

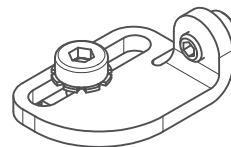

To be used together with the fixing bracket for T-slot in case the T-slot is not through (DF-MSS12TO)