

**FOTOCELLULE CILINDRICHE M18  
TASTEGGIO DIRETTO**

**SERIE OCV81/D *SERIES***

***M18 PHOTOELECTRIC CYLINDRICAL  
SENSORS DIFFUSE TYPE***

**FOTOCEDURE CILINDRICHE M18 - TASTEGGIO DIRETTO**  
**M18 CYLINDRICAL PHOTOELECTRIC SENSORS - DIFFUSE TYPE**



- ➔ FOTOCEDURE STANDARD M18 A TASTEGGIO
- ➔ DIRETTO, CON TESTINA A 90° E FREQUENZA DI LAVORO 10 kHz
- ➔ VERSIONI A 100, 200, 400, 600, 1000 mm DI PORTATA.
- ➔ USCITA CAVO O CONNETTORE M12.
- ➔ CONTENITORE PLASTICO O METALLICO.

- ➔ *STANDARD M18 PHOTOELECTRIC SENSORS*
- ➔ *DIFFUSE TYPE, WITH RADIAL CYLINDRICAL HOUSING AND 10 kHz WORKING FREQUENCY.*
- ➔ *SENSING DISTANCE VERSIONS 100, 200, 400 & 600, 1000 mm.*
- ➔ *CABLE OUT OR M12 PLUG-IN CONNECTOR.*
- ➔ *PLASTIC OR METAL BODY*

**COME ORDINARE**
**HOW TO ORDER**

**OCV81 - / D1 A P NO R M C5**

**VERSIONE/ VERSION**

- = Versione standard  
*Standard version*
- \*K = Versione ad alte frequenze 10 kHz  
*High frequency 10 kHz version*

\* SOLO VERSIONI D e D1

**SERIE/ SERIES**

- D = Tasteggio diretto/ *Diffuse type 100 mm*
- D1 = Tasteggio diretto/ *Diffuse type 200 mm*
- D2 = Tasteggio diretto/ *Diffuse type 400 mm*
- D3 = Tasteggio diretto/ *Diffuse type 600 mm*
- D4 = Tasteggio diretto/ *Diffuse type 1000 mm*

**TIPO DI OTTICA/ OPTICAL TYPE**

- = Ottica assiale/ *Assial optical*
- §A = Ottica radiale/ *Radial optical*

§ SALVO VERSIONI D4

**ELETTRONICA/ ELECTRONICS**

- P = PNP (*Vcc/Vdc*)
- N = NPN (*Vcc/Vdc*)
- ®C3 = Vca / Vac

® SALVO VERSIONI K, D3 e D4

**CONNESSIONE LINK**

- = Cavo (2m)  
*Cable (2m)*
- Kx = Metraggio cavo a richiesta  
*Cable lenght upon request*
- KR = Uscita cavo 90°  
*90 degrees angled cable output*
- C5 = Connettore M12  
*M12 Connector*

**MATERIALE CORPO BODY MATERIAL**

- = Plastico/ *Plastic*
- M = Metallico/ *Metal*

**SENSIBILITA'/ SENSITIVITY**

- = Fissa/ *Fixed*
- R = Regolabile/ *Adjustment*

**USCITA/ OUTPUT**

- NO = Normalmente aperta (impulso luce)  
*Normally open (light on)*
- NC = Normalmente chiusa (impulso buio)  
*Normally closed (dark-on)*
- #SC = NO/NC selezionabile (3 Fili)  
*NO/NC programmable (3 Wires)*
- #SC4 = 2 uscite, NO+NC (4 Fili)  
*2 outputs, NO +NC (4 Wires)*

# SALVO VERSIONI K

**CARATTERISTICHE ELETTRICHE**
**GENERALI/ GENERALS**
**ELECTRICAL FEATURES**
**VERSIONE IN C.C.**
**D.C. TYPE**

ALIMENTAZIONE	10 ÷ 30 Vdc	SUPPLY VOLTAGE
ONDULAZIONE RESIDUA	≤ 10%	RIPPLE
ASSORBIMENTO	< 25 mA	POWER CONSUMPTION
CARICO MASSIMO	250 mA	MAXIMUM LOAD
CADUTA DI TENSIONE	< 2V @ 200 mA	VOLTAGE DROP
PROTEZIONE C.C.	SI / YES	SHORT CIRCUIT PROTECTION
PROTEZIONE INVERSIONE DI POLARITA'	SI / YES	POLARITY REVERSAL PROTECTION
COMPATIBILITA' ELETTROMAGNETICA CE	EN 60947-5-2	CE COMPLIANCE

**VERSIONE IN A.C.**
**A.C. TYPE**

ALIMENTAZIONE	20 ÷ 230 Vac	SUPPLY VOLTAGE
ASSORBIMENTO	< 4 mA	POWER CONSUMPTION
CARICO MASSIMO	300 mA	MAXIMUM LOAD
CADUTA DI TENSIONE	< 3 V	VOLTAGE DROP
COMPATIBILITA' ELETTROMAGNETICA CE	EN 60947-5-2	CE COMPLIANCE

**CARATTERISTICHE TECNICHE**
**TASTEGGIO DIRETTO/ DIFFUSE TYPE**
**TECHNICAL FEATURES**

MODELLO	FISSO	D	DA	D1	D1A	D2	D2A	D3	D3A	D4	FIXED	MODEL
	REG.	-	-	D1...R	D1A...R	D2...R	D2A...R	D3...R	D3A...R	D4...R	ADJ.	
DISTANZA DI RILEVAMENTO (mm)		100*		200*		400**		600**		1000**		SENSING DISTANCE (mm)
		-		1 ÷ 200		1 ÷ 400		1 ÷ 600		1 ÷ 1000		
TIPO DI EMISSIONE	IR MODULATO 880 nm - PULSED IR 880 nm											EMISSION TYPE
FREQUENZA DI COMMUTAZIONE MASSIMA	(C.C.) 150 Hz (D.C.)											MAXIMUM OPERATING FREQUENCY
	(C.A.) 15 Hz (A.C.)											
TEMPERATURA DI LAVORO	-10°C ÷ 50°C											WORKING TEMPERATURE
TEMPERATURA DI STOCCAGGIO	-25°C ÷ 70°C											STOCK TEMPERATURE
MATERIALE CORPO PLASTICO	ABS											PLASTIC BODY MATERIAL
MATERIALE CORPO METALLICO	OTTONE NICHELATO / NICHEL PLATED BRASS											METAL BODY MATERIAL
MATERIALE LENTI	PMMA											LENSES MATERIAL
GRADO DI PROTEZIONE	IP65											IP RATING

**CARATTERISTICHE TECNICHE**
**TASTEGGIO DIRETTO 10 kHz/ 10 kHz DIFFUSE TYPE**
**TECHNICAL FEATURES**

MODELLO	FISSO	D	DA	D1	D1A	FIXED	MODEL
	REG	-	-	D1...R	D1A...R	ADJ.	
DISTANZA DI RILEVAMENTO (mm)	FISSO	100*		200*		FIXED	SENSING DISTANCE (mm)
	REG	-		2 ÷ 200		ADJ.	
EMISSIONE	IR MODULATO 880 nm - PULSED IR 880 nm						EMISSION
FREQUENZA DI COMMUTAZIONE MASSIMA	10 kHz						MAXIMUM WORKING FREQUENCY
TEMPERATURA DI LAVORO	-10°C ÷ 50°C						WORKING TEMPERATURE
TEMPERATURA DI STOCCAGGIO	-25°C ÷ 70°C						STORAGE TEMPERATURE
MATERIALE CORPO PLASTICO	ABS						PLASTIC BODY MATERIAL
MATERIALE CORPO METALLICO	OTTONE NICHELATO / NICHEL PLATED BRASS						METAL BODY MATERIAL
MATERIALE LENTI	PMMA						LENSES MATERIAL
GRADO DI PROTEZIONE	IP66						PROTECTION RATING

\* PORTATA DEFINITA SU CARTA BIANCA CON RIFLESSIONE DEL 90% DIMENSIONI 100 x 100 mm  
SENSING DISTANCE DEFINED ON WHITE PAPER WITH 90% REFLEX DIMENSIONS 100 x 100 mm

\*\* PORTATA DEFINITA SU CARTA BIANCA CON RIFLESSIONE DEL 90% DIMENSIONI 200 x 200 mm  
SENSING DISTANCE DEFINED ON WHITE PAPER WITH 90% REFLEX DIMENSIONS 200 x 200 mm

File Name:ocv81d.cdr  
Rev: 0.2

La Ditta costruttrice si riserva di apportare qualunque modifica ritenga utile senza preavviso.  
Manufacturer reserve itself all the rights to change without notice.

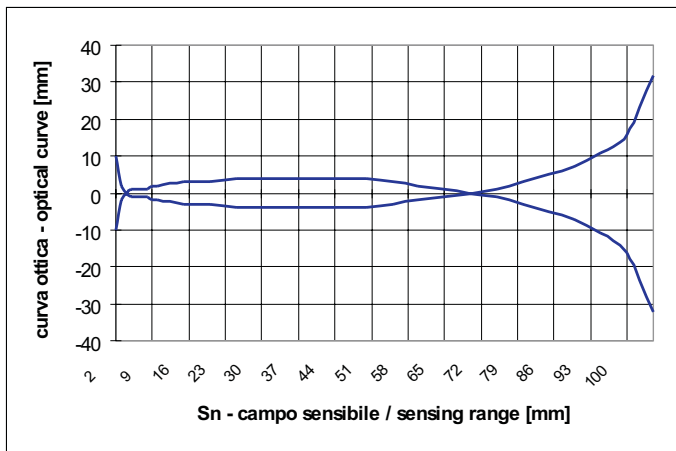
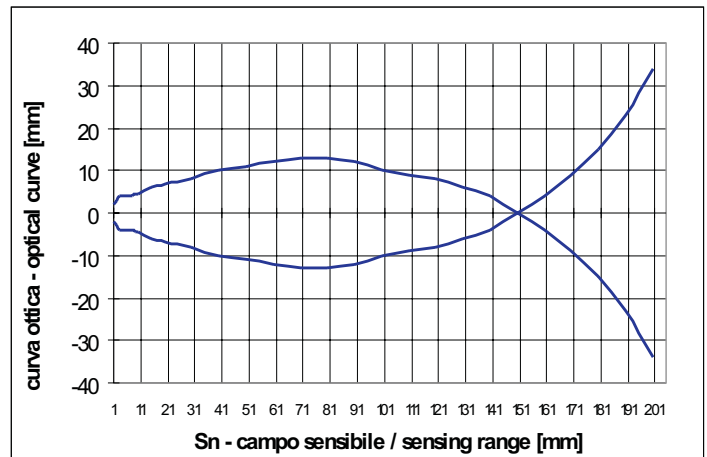
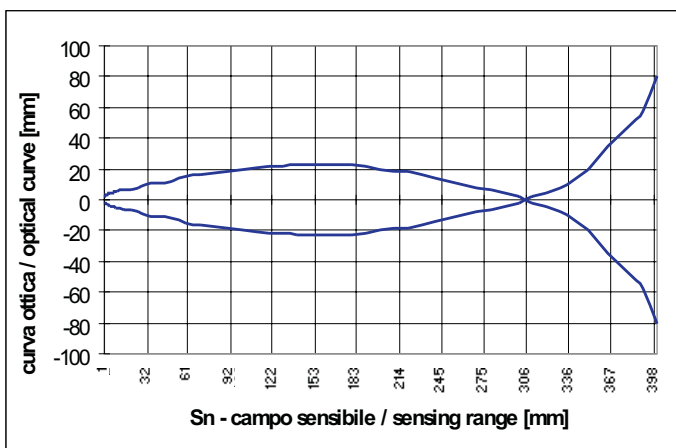
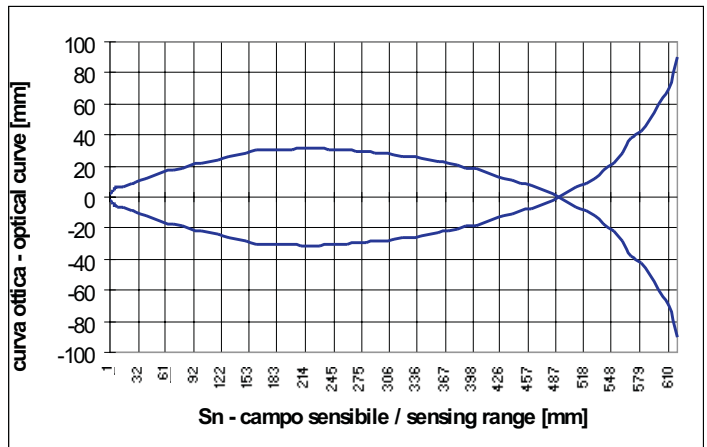
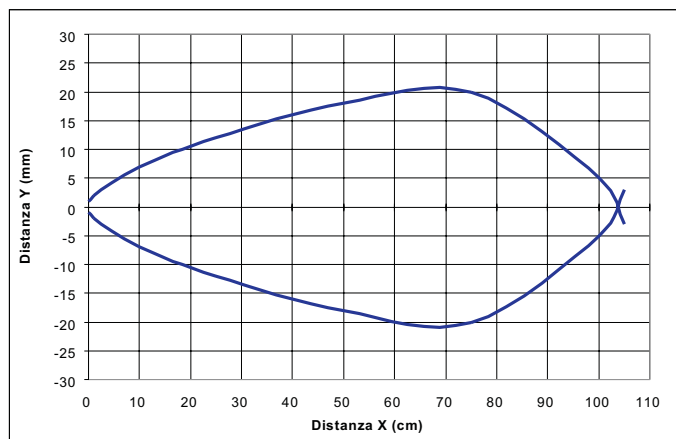
**MODELLO D, DA TYPE  
MODELLO K/D, K/DA TYPE**

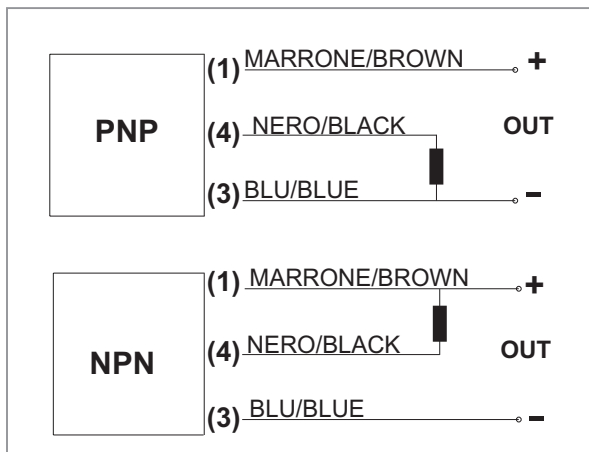
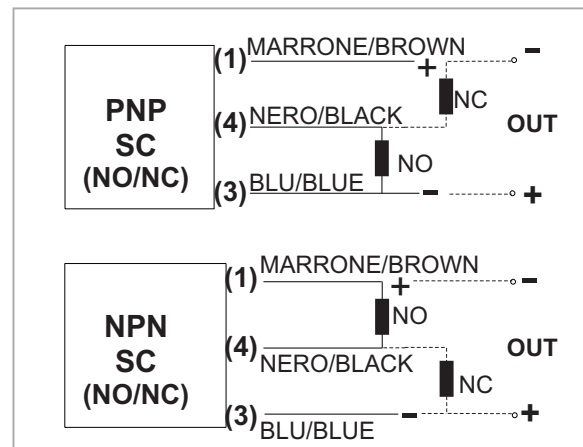
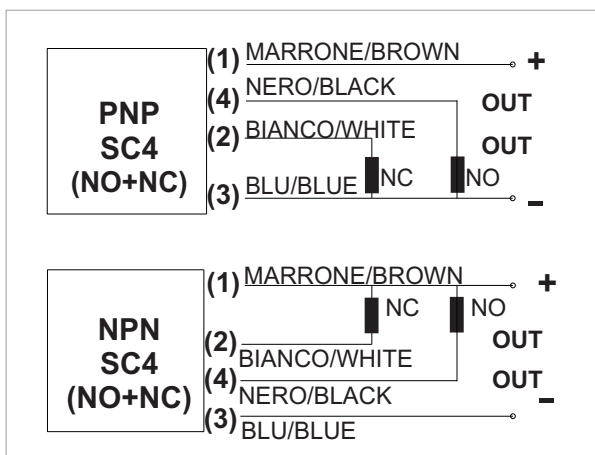
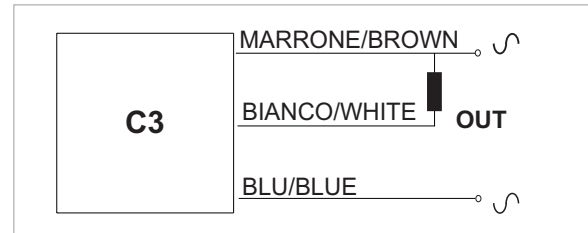
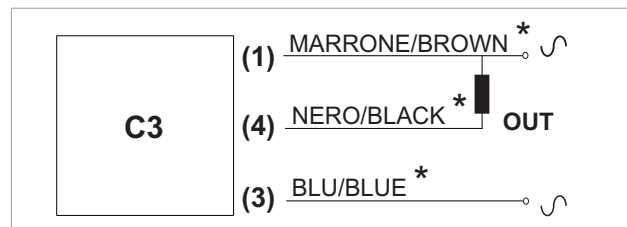
**MODELLO D1, D1A TYPE  
MODELLO K/D1, K/D1A TYPE**

**MODELLO D2, D2A TYPE**

**MODELLO D3, D3A TYPE**

**MODELLO D4 TYPE**

**3 FILI C.C. / 3 WIRES D.C.**

**3 FILI SC (C.C.) / 3 WIRES SC (D.C.)**

**4 FILI SC (C.C.) / 4 WIRES (D.C.)**

**3 FILI C.A. / 3 WIRES (A.C.)  
USCITA CAVO/ CABLE OUTPUT**

**3 FILI C.A. / 3 WIRES (A.C.)  
USCITA CONNETTORE/ CONNECTOR OUTPUT**

\* COLORE FILI DEL CONNETTORE/ CONNECTOR WIRE COLOR

**TASTEGGIO DIRETTO**
**DIFFUSE TYPE**
**ELENCO PRODOTTI**
**OTTICA ASSIALE / ASSIAL OPTICAL**
**PRODUCTS LIST**
**MODELLO D - Sn = 100 mm**
**D TYPE - Sn = 100 mm**

USCITA/OUTPUT	PLASTICA / PLASTIC		METALLICA / METAL	
	CAVO / CABLE	CONNETTORE/CONNECTOR	CAVO / CABLE	CONNETTORE/CONNECTOR
PNP NO	OCV81/DPNO	OCV81/DPNOC5	OCV81/DPNOM	OCV81/DPNOMC5
PNP NC	OCV81/DPNC	OCV81/DPNCC5	OCV81/DPNCM	OCV81/DPNCMC5
PNP SC	OCV81/DPSC	OCV81/DPSCC5	OCV81/DPSCM	OCV81/DPSCMC5
PNP SC4	OCV81/DPSC4	OCV81/DPSC4C5	OCV81/DPSC4M	OCV81/DPSC4MC5
NPN NO	OCV81/DNNO	OCV81/DNNOC5	OCV81/DNNOM	OCV81/DNNOMC5
NPN NC	OCV81/DNNC	OCV81/DNCC5	OCV81/DNNCM	OCV81/DNNCMC5
NPN SC	OCV81/DNSC	OCV81/DNSCC5	OCV81/DNSCM	OCV81/DNSCMC5
NPN SC4	OCV81/DNSC4	OCV81/DNSC4C5	OCV81/DNSC4M	OCV81/DNSC4MC5
C.A. NO	OCV81/DC3NO	OCV81/DC3NOC5	OCV81/DC3NOM	OCV81/DC3NOMC5
C.A. NC	OCV81/DC3NC	OCV81/DC3NCC5	OCV81/DC3NCM	OCV81/DC3NCMC5

**MODELLO D1 - Sn = 200 mm**
**D1 TYPE - Sn = 200 mm**

USCITA/OUTPUT	PLASTICA/PLASTIC		METALLICA/METAL	
	CAVO/CABLE	CONNETTORE/CONNECTOR	CAVO/CABLE	CONNETTORE/CONNECTOR
PNP NO	OCV81/D1PNO	OCV81/D1PNOC5	OCV81/D1PNOM	OCV81/D1PNOMC5
PNP NC	OCV81/D1PNC	OCV81/D1PNCC5	OCV81/D1PNCM	OCV81/D1PNCMC5
PNP SC	OCV81/D1PSC	OCV81/D1PSCC5	OCV81/D1PSCM	OCV81/D1PSCMC5
PNP SC4	OCV81/D1PSC4	OCV81/D1PSC4C5	OCV81/D1PSC4M	OCV81/D1PSC4MC5
NPN NO	OCV81/D1NNO	OCV81/D1NNOC5	OCV81/D1NNOM	OCV81/D1NNOMC5
NPN NC	OCV81/D1NNC	OCV81/D1NNCC5	OCV81/D1NNCM	OCV81/D1NNCMC5
NPN SC	OCV81/D1NSC	OCV81/D1NSCC5	OCV81/D1NSCM	OCV81/D1NSCMC5
NPN SC4	OCV81/D1NSC4	OCV81/D1NSC4C5	OCV81/D1NSC4M	OCV81/D1NSC4MC5
C.A. NO	OCV81/D1C3NO	OCV81/D1C3NOC5	OCV81/D1C3NOM	OCV81/D1C3NOMC5
C.A. NC	OCV81/D1C3NC	OCV81/D1C3NCC5	OCV81/D1C3NCM	OCV81/D1C3NCMC5

**MODELLO D1 - Sn = 200 mm - REGOLABILE**
**D1 TYPE - Sn = 200 mm - ADJUSTABLE**

USCITA/OUTPUT	PLASTICA / PLASTIC		METALLICA / METAL	
	CAVO/CABLE	CONNETTORE/CONNECTOR	CAVO/CABLE	CONNETTORE/CONNECTOR
PNP NO	OCV81/D1PNOR	-	OCV81/D1PNORM	OCV81/D1PNORMC5
PNP NC	OCV81/D1PNCR	-	OCV81/D1PNCRM	OCV81/D1PNCRM5
PNP SC	OCV81/D1PSCR	-	OCV81/D1PSCRM	OCV81/D1PSCRM5
PNP SC4	OCV81/D1PSC4R	-	OCV81/D1PSC4RM	OCV81/D1PSC4RM5
NPN NO	OCV81/D1NNOR	-	OCV81/D1NNORM	OCV81/D1NNORMC5
NPN NC	OCV81/D1NNCR	-	OCV81/D1NNCRM	OCV81/D1NNCRM5
NPN SC	OCV81/D1NSCR	-	OCV81/D1NSCRM	OCV81/D1NSCRM5
NPN SC4	OCV81/D1NSC4R	-	OCV81/D1NSC4RM	OCV81/D1NSC4RM5
C.A. NO	OCV81/D1C3NOR	-	OCV81/D1C3NORM	OCV81/D1C3NORMC5
C.A. NC	OCV81/D1C3NCR	-	OCV81/D1C3NCRM	OCV81/D1C3NCRM5

**MODELLO D2 - Sn = 400 mm**
**D2 TYPE - Sn = 400 mm**

USCITA/OUTPUT	PLASTICA/PLASTIC		METALLICA/METAL	
	CAVO/CABLE	CONNETTORE/CONNECTOR	CAVO/CABLE	CONNETTORE/CONNECTOR
PNP NO	OCV81/D2PNO	OCV81/D2PNOC5	OCV81/D2PNOM	OCV81/D2PNOMC5
PNP NC	OCV81/D2PNC	OCV81/D2PNCC5	OCV81/D2PNCM	OCV81/D2PNCMC5
PNP SC	OCV81/D2PSC	OCV81/D2PSCC5	OCV81/D2PSCM	OCV81/D2PSCMC5
PNP SC4	OCV81/D2PSC4	OCV81/D2PSC4C5	OCV81/D2PSC4M	OCV81/D2PSC4MC5
NPN NO	OCV81/D2NNO	OCV81/D2NNOC5	OCV81/D2NNOM	OCV81/D2NNOMC5
NPN NC	OCV81/D2NNC	OCV81/D2NNCC5	OCV81/D2NNCM	OCV81/D2NNCMC5
NPN SC	OCV81/D2NSC	OCV81/D2NSCC5	OCV81/D2NSCM	OCV81/D2NSCMC5
NPN SC4	OCV81/D2NSC4	OCV81/D2NSC4C5	OCV81/D2NSC4M	OCV81/D2NSC4MC5
C.A. NO	OCV81/D2C3NO	OCV81/D2C3NOC5	OCV81/D2C3NOM	OCV81/D2C3NOMC5
C.A. NC	OCV81/D2C3NC	OCV81/D2C3NCC5	OCV81/D2C3NCM	OCV81/D2C3NCMC5

**MODELLO D2 - Sn = 400 mm - REGOLABILE**
**D2 TYPE - Sn = 400 mm ADJUSTABLE**

USCITA/OUTPUT	PLASTICA / PLASTIC		METALLICA / METAL	
	CAVO/CABLE	CONNETTORE/CONNECTOR	CAVO/CABLE	CONNETTORE/CONNECTOR
PNP NO	OCV81/D2PNOR	-	OCV81/D2PNORM	OCV81/D2PNORMC5
PNP NC	OCV81/D2PNCR	-	OCV81/D2PNCRM	OCV81/D2PNCRM5
PNP SC	OCV81/D2PSCR	-	OCV81/D2PSCRM	OCV81/D2PSCRM5
PNP SC4	OCV81/D2PSC4R	-	OCV81/D2PSC4RM	OCV81/D2PSC4RM5
NPN NO	OCV81/D2NNOR	-	OCV81/D2NNORM	OCV81/D2NNORM5
NPN NC	OCV81/D2NNCR	-	OCV81/D2NNCRM	OCV81/D2NNCRM5
NPN SC	OCV81/D2NSCR	-	OCV81/D2NSCRM	OCV81/D2NSCRM5
NPN SC4	OCV81/D2NSC4R	-	OCV81/D2NSC4RM	OCV81/D2NSC4RM5
C.A. NO	OCV81/D2C3NOR	-	OCV81/D2C3NORM	OCV81/D2C3NORM5
C.A. NC	OCV81/D2C3NCR	-	OCV81/D2C3NCRM	OCV81/D2C3NCRM5

**MODELLO D3 - Sn = 600 mm**
**D3 TYPE - Sn = 600 mm**

USCITA/OUTPUT	PLASTICA / PLASTIC		METALLICA / METAL	
	CAVO/CABLE	CONNETTORE/CONNECTOR	CAVO/CABLE	CONNETTORE/CONNECTOR
PNP NO	OCV81/D3PNO	OCV81/D3PNOC5	OCV81/D3PNOM	OCV81/D3PNOMC5
PNP NC	OCV81/D3PNC	OCV81/D3PNCC5	OCV81/D3PNCM	OCV81/D3PNCMC5
PNP SC	OCV81/D3PSC	OCV81/D3PSCC5	OCV81/D3PSCM	OCV81/D3PSCMC5
PNP SC4	OCV81/D3PSC4	OCV81/D3PSC4C5	OCV81/D3PSC4M	OCV81/D3PSC4MC5
NPN NO	OCV81/D3NNO	OCV81/D3NNOC5	OCV81/D3NNOM	OCV81/D3NNOMC5
NPN NC	OCV81/D3NNC	OCV81/D3NNCC5	OCV81/D3NNCM	OCV81/D3NNCMC5
NPN SC	OCV81/D3NSC	OCV81/D3NSCC5	OCV81/D3NSCM	OCV81/D3NSCMC5
NPN SC4	OCV81/D3NSC4	OCV81/D3NSC4C5	OCV81/D3NSC4M	OCV81/D3NSC4MC5



**MODELLO D3 - Sn = 600 mm - REGOLABILE**
**D3 TYPE - Sn = 600 mm ADJUSTABLE**

USCITA/OUTPUT	PLASTICA / PLASTIC		METALLICA / METAL	
	CAVO / CABLE	CONNETTORE / CONNECTOR	CAVO / CABLE	CONNETTORE / CONNECTOR
PNP NO	OCV81/D3PNOR	-	OCV81/D3PNORM	OCV81/D3PNORMC5
PNP NC	OCV81/D3PNCR	-	OCV81/D3PNCRM	OCV81/D3PNCRM5
PNP SC	OCV81/D3PSCR	-	OCV81/D3PSCRM	OCV81/D3PSCRM5
PNP SC4	OCV81/D3PSC4R	-	OCV81/D3PSC4RM	OCV81/D3PSC4RM5
NPN NO	OCV81/D3NNOR	-	OCV81/D3NNORM	OCV81/D3NNORM5
NPN NC	OCV81/D3NNCR	-	OCV81/D3NNCRM	OCV81/D3NNCRM5
NPN SC	OCV81/D3NSCR	-	OCV81/D3NSCRM	OCV81/D3NSCRM5
NPN SC4	OCV81/D3NSC4R	-	OCV81/D3NSC4RM	OCV81/D3NSC4RM5

**MODELLO D4 - Sn = 1000 mm**
**D4 TYPE - Sn = 1000 mm**

USCITA/OUTPUT	PLASTICA / PLASTIC		METALLICA / METAL	
	CAVO / CABLE	CONNETTORE / CONNECTOR	CAVO / CABLE	CONNETTORE / CONNECTOR
PNP NO	OCV81/D4PNO	OCV81/D4PNO5	OCV81/D4PNOM	OCV81/D4PNOM5
PNP NC	OCV81/D4PNC	OCV81/D4PNC5	OCV81/D4PNCM	OCV81/D4PNCM5
PNP SC	OCV81/D4PSC	OCV81/D4PSC5	OCV81/D4PSCM	OCV81/D4PSCM5
PNP SC4	OCV81/D4PSC4	OCV81/D4PSC45	OCV81/D4PSC4M	OCV81/D4PSC4M5
NPN NO	OCV81/D4NNO	OCV81/D4NNO5	OCV81/D4NNOM	OCV81/D4NNOM5
NPN NC	OCV81/D4NNC	OCV81/D4NNC5	OCV81/D4NNCM	OCV81/D4NNCM5
NPN SC	OCV81/D4NSC	OCV81/D4NSC5	OCV81/D4NSCM	OCV81/D4NSCM5
NPN SC4	OCV81/D4NSC4	OCV81/D4NSC45	OCV81/D4NSC4M	OCV81/D4NSC4M5

**MODELLO D4 - Sn = 1000 mm - REGOLABILE**
**D4 TYPE - Sn = 1000 mm - ADJUSTABLE**

USCITA/OUTPUT	PLASTICA / PLASTIC		METALLICA / METAL	
	CAVO / CABLE	CONNETTORE / CONNECTOR	CAVO / CABLE	CONNETTORE / CONNECTOR
PNP NO	OCV81/D4PNOR	-	OCV81/D4PNORM	OCV81/D4PNORM5
PNP NC	OCV81/D4PNCR	-	OCV81/D4PNCRM	OCV81/D4PNCRM5
PNP SC	OCV81/D4PSCR	-	OCV81/D4PSCRM	OCV81/D4PSCRM5
PNP SC4	OCV81/D4PSC4R	-	OCV81/D4PSC4RM	OCV81/D4PSC4RM5
NPN NO	OCV81/D4NNOR	-	OCV81/D4NNORM	OCV81/D4NNORM5
NPN NC	OCV81/D4NNCR	-	OCV81/D4NNCRM	OCV81/D4NNCRM5
NPN SC	OCV81/D4NSCR	-	OCV81/D4NSCRM	OCV81/D4NSCRM5
NPN SC4	OCV81/D4NSC4R	-	OCV81/D4NSC4RM	OCV81/D4NSC4RM5



**TASTEGGIO DIRETTO RADIALE**
**RADIAL DIFFUSE TYPE**
**ELENCO PRODOTTI**
**OTTICA RADIALE/ RADIAL OPTICAL**
**PRODUCTS LIST**
**MODELLO D - Sn = 100 mm**
**D TYPE - Sn = 100 mm**

USCITA/OUTPUT	PLASTICA / PLASTIC		METALLICA / METAL	
	CAVO / CABLE	CONNETTORE/CONNECTOR	CAVO / CABLE	CONNETTORE/CONNECTOR
PNP NO	OCV81/DAPNO	OCV81/DAPNOC5	OCV81/DAPNOM	OCV81/DAPNOMC5
PNP NC	OCV81/DAPNC	OCV81/DAPNCC5	OCV81/DAPNCM	OCV81/DAPNCMC5
PNP SC	OCV81/DAPSC	OCV81/DAPSCC5	OCV81/DAPSCM	OCV81/DAPSCMC5
PNP SC4	OCV81/DAPSC4	OCV81/DAPSC4C5	OCV81/DAPSC4M	OCV81/DAPSC4MC5
NPN NO	OCV81/DANNO	OCV81/DANNOC5	OCV81/DANNOM	OCV81/DANNOMC5
NPN NC	OCV81/DANNC	OCV81/DANNCC5	OCV81/DANNCM	OCV81/DANNCMC5
NPN SC	OCV81/DANSC	OCV81/DANSCC5	OCV81/DANSCM	OCV81/DANSCMC5
NPN SC4	OCV81/DANSC4	OCV81/DANSC4C5	OCV81/DANSC4M	OCV81/DANSC4MC5
C.A. NO	OCV81/DAC3NO	OCV81/DAC3NOC5	OCV81/DAC3NOM	OCV81/DAC3NOMC5
C.A. NC	OCV81/DAC3NC	OCV81/DAC3NCC5	OCV81/DAC3NCM	OCV81/DAC3NCMC5

**MODELLO D1 - Sn = 200 mm**
**D1 TYPE - Sn = 200 mm**

USCITA/OUTPUT	PLASTICA/PLASTIC		METALLICA/METAL	
	CAVO/CABLE	CONNETTORE/CONNECTOR	CAVO/CABLE	CONNETTORE/CONNECTOR
PNP NO	OCV81/D1APNO	OCV81/D1APNOC5	OCV81/D1APNOM	OCV81/D1APNOMC5
PNP NC	OCV81/D1APNC	OCV81/D1APNCC5	OCV81/D1APNCM	OCV81/D1APNCMC5
PNP SC	OCV81/D1APSC	OCV81/D1APSCC5	OCV81/D1APSCM	OCV81/D1APSCMC5
PNP SC4	OCV81/D1APSC4	OCV81/D1APSC4C5	OCV81/D1APSC4M	OCV81/D1APSC4MC5
NPN NO	OCV81/D1ANNO	OCV81/D1ANNOC5	OCV81/D1ANNOM	OCV81/D1ANNOMC5
NPN NC	OCV81/D1ANNC	OCV81/D1ANNCC5	OCV81/D1ANNCM	OCV81/D1ANNCMC5
NPN SC	OCV81/D1ANSC	OCV81/D1ANSCC5	OCV81/D1ANSCM	OCV81/D1ANSCMC5
NPN SC4	OCV81/D1ANSC4	OCV81/D1ANSC4C5	OCV81/D1ANSC4M	OCV81/D1ANSC4MC5
C.A. NO	OCV81/D1AC3NO	OCV81/D1AC3NOC5	OCV81/D1AC3NOM	OCV81/D1AC3NOMC5
C.A. NC	OCV81/D1AC3NC	OCV81/D1AC3NCC5	OCV81/D1AC3NCM	OCV81/D1AC3NCMC5

**MODELLO D1 - Sn = 200 mm - REGOLABILE**
**D1 TYPE - Sn = 200 mm - ADJUSTABLE**

USCITA/OUTPUT	PLASTICA / PLASTIC		METALLICA / METAL	
	CAVO/CABLE	CONNETTORE/CONNECTOR	CAVO/CABLE	CONNETTORE/CONNECTOR
PNP NO	OCV81/D1APNOR	-	OCV81/D1APNORM	OCV81/D1APNORMC5
PNP NC	OCV81/D1APNCR	-	OCV81/D1APNCRM	OCV81/D1APNCRM5
PNP SC	OCV81/D1APSCR	-	OCV81/D1APSCRM	OCV81/D1APSCRM5
PNP SC4	OCV81/D1APSC4R	-	OCV81/D1APSC4RM	OCV81/D1APSC4RM5
NPN NO	OCV81/D1ANNOR	-	OCV81/D1ANNORM	OCV81/D1ANNORMC5
NPN NC	OCV81/D1ANNCR	-	OCV81/D1ANNCRM	OCV81/D1ANNCRM5
NPN SC	OCV81/D1ANSCR	-	OCV81/D1ANSCRM	OCV81/D1ANSCRM5
NPN SC4	OCV81/D1ANSC4R	-	OCV81/D1ANSC4RM	OCV81/D1ANSC4RM5
C.A. NO	OCV81/D1AC3NOR	-	OCV81/D1AC3NORM	OCV81/D1AC3NORMC5
C.A. NC	OCV81/D1AC3NCR	-	OCV81/D1AC3NCRM	OCV81/D1AC3NCRM5

**MODELLO D2 - Sn = 400 mm**
**D2 TYPE - Sn = 400 mm**

USCITA/OUTPUT	PLASTICA/PLASTIC		METALLICA/METAL	
	CAVO/CABLE	CONNETTORE/CONNECTOR	CAVO/CABLE	CONNETTORE/CONNECTOR
PNP NO	OCV81/D2APNO	OCV81/D2APNOC5	OCV81/D2APNOM	OCV81/D2APNOMC5
PNP NC	OCV81/D2APNC	OCV81/D2APNCC5	OCV81/D2APNCM	OCV81/D2APNCMC5
PNP SC	OCV81/D2APSC	OCV81/D2APSCC5	OCV81/D2APSCM	OCV81/D2APSCMC5
PNP SC4	OCV81/D2APSC4	OCV81/D2APSC4C5	OCV81/D2APSC4M	OCV81/D2APSC4MC5
NPN NO	OCV81/D2ANNO	OCV81/D2ANNOC5	OCV81/D2ANNOM	OCV81/D2ANNOMC5
NPN NC	OCV81/D2ANNC	OCV81/D2ANNCC5	OCV81/D2ANNCM	OCV81/D2ANNCMC5
NPN SC	OCV81/D2ANSC	OCV81/D2ANSCC5	OCV81/D2ANSCM	OCV81/D2ANSCMC5
NPN SC4	OCV81/D2ANSC4	OCV81/D2ANSC4C5	OCV81/D2ANSC4M	OCV81/D2ANSC4MC5
C.A. NO	OCV81/D2AC3NO	OCV81/D2AC3NOC5	OCV81/D2AC3NOM	OCV81/D2AC3NOMC5
C.A. NC	OCV81/D2AC3NC	OCV81/D2AC3NCC5	OCV81/D2AC3NCM	OCV81/D2AC3NCMC5

**MODELLO D2 - Sn = 400 mm - REGOLABILE**
**D2 TYPE - Sn = 400 mm ADJUSTABLE**

USCITA/OUTPUT	PLASTICA /PLASTIC		METALLICA /METAL	
	CAVO/CABLE	CONNETTORE/CONNECTOR	CAVO/CABLE	CONNETTORE/CONNECTOR
PNP NO	OCV81/D2APNOR	-	OCV81/D2APNORM	OCV81/D2APNORMC5
PNP NC	OCV81/D2APNCR	-	OCV81/D2APNCRM	OCV81/D2APNCRM5
PNP SC	OCV81/D2APSCR	-	OCV81/D2APSCRM	OCV81/D2APSCRM5
PNP SC4	OCV81/D2APSC4R	-	OCV81/D2APSC4RM	OCV81/D2APSC4RM5
NPN NO	OCV81/D2ANNOR	-	OCV81/D2ANNORM	OCV81/D2ANNORMC5
NPN NC	OCV81/D2ANNCR	-	OCV81/D2ANNCRM	OCV81/D2ANNCRM5
NPN SC	OCV81/D2ANSCR	-	OCV81/D2ANSCRM	OCV81/D2ANSCRM5
NPN SC4	OCV81/D2ANSC4R	-	OCV81/D2ANSC4RM	OCV81/D2ANSC4RM5
C.A. NO	OCV81/D2AC3NOR	-	OCV81/D2AC3NORM	OCV81/D2AC3NORMC5
C.A. NC	OCV81/D2AC3NCR	-	OCV81/D2AC3NCRM	OCV81/D2AC3NCRM5

**MODELLO D3 - Sn = 600 mm**
**D3 TYPE - Sn = 600 mm**

USCITA/OUTPUT	PLASTICA / PLASTIC		METALLICA / METAL	
	CAVO/CABLE	CONNETTORE/CONNECTOR	CAVO/CABLE	CONNETTORE/CONNECTOR
PNP NO	OCV81/D3APNO	OCV81/D3APNOC5	OCV81/D3APNOM	OCV81/D3APNOMC5
PNP NC	OCV81/D3APNC	OCV81/D3APNCC5	OCV81/D3APNCM	OCV81/D3APNCMC5
PNP SC	OCV81/D3APSC	OCV81/D3APSCC5	OCV81/D3APSCM	OCV81/D3APSCMC5
PNP SC4	OCV81/D3APSC4	OCV81/D3APSC4C5	OCV81/D3APSC4M	OCV81/D3APSC4MC5
NPN NO	OCV81/D3ANNO	OCV81/D3ANNOC5	OCV81/D3ANNOM	OCV81/D3ANNOMC5
NPN NC	OCV81/D3ANNC	OCV81/D3ANNCC5	OCV81/D3ANNCM	OCV81/D3ANNCMC5
NPN SC	OCV81/D3ANSC	OCV81/D3ANSCC5	OCV81/D3ANSCM	OCV81/D3ANSCMC5
NPN SC4	OCV81/D3ANSC4	OCV81/D3ANSC4C5	OCV81/D3ANSC4M	OCV81/D3ANSC4MC5

**MODELLO D3 - Sn = 600 mm - REGOLABILE**
**D3 TYPE - Sn = 600 mm ADJUSTABLE**

USCITA/OUTPUT	PLASTICA / PLASTIC		METALLICA / METAL	
	CAVO/CABLE	CONNETTORE/CONNECTOR	CAVO/CABLE	CONNETTORE/CONNECTOR
PNP NO	OCV81/D3APNOR	-	OCV81/D3APNORM	OCV81/D3APNORMC5
PNP NC	OCV81/D3APNCR	-	OCV81/D3APNCRM	OCV81/D3APNCRM5
PNP SC	OCV81/D3APSCR	-	OCV81/D3APSCRM	OCV81/D3APSCRM5
PNP SC4	OCV81/D3APSC4R	-	OCV81/D3APSC4RM	OCV81/D3APSC4RM5
NPN NO	OCV81/D3ANNOR	-	OCV81/D3ANNORM	OCV81/D3ANNORM5
NPN NC	OCV81/D3ANNCR	-	OCV81/D3ANNCRM	OCV81/D3ANNCRM5
NPN SC	OCV81/D3ANSCR	-	OCV81/D3ANSCRM	OCV81/D3ANSCRM5
NPN SC4	OCV81/D3ANSC4R	-	OCV81/D3ANSC4RM	OCV81/D3ANSC4RM5

**TASTEGGIO**  
**ALTE FREQUENZE 10 kHz**

*DIFFUSE TYPE*  
*10 kHz WORKING FREQUENCY*

**ELENCO PRODOTTI**
**ALTE FREQUENZE 10 kHz / 10 kHz HIGH FREQUENCY**
**PRODUCTS LIST**
**MODELLO D - Sn = 100 mm**
**D TYPE - Sn = 100 mm**

USCITA/OUTPUT	PLASTICA / PLASTIC		METALLICA / METAL	
	CAVO / CABLE	CONNETTORE/CONNECTOR	CAVO / CABLE	CONNETTORE/CONNECTOR
PNP NO	OCV81K/DPNO	OCV81K/DPNOC5	OCV81K/DPNOM	OCV81K/DPNOMC5
PNP NC	OCV81K/DPNC	OCV81K/DPNCC5	OCV81K/DPNCM	OCV81K/DPNCMC5
NPN NO	OCV81K/DNNO	OCV81K/DNNOC5	OCV81K/DNNOM	OCV81K/DNNOMC5
NPN NC	OCV81K/DNNC	OCV81K/DNNCC5	OCV81K/DNNCM	OCV81K/DNNCMC5

**MODELLO D1 - Sn = 200 mm**
**D1 TYPE - Sn = 200 mm**

USCITA/OUTPUT	PLASTICA / PLASTIC		METALLICA / METAL	
	CAVO/CABLE	CONNETTORE/CONNECTOR	CAVO/CABLE	CONNETTORE/CONNECTOR
PNP NO	OCV81K/D1PNO	OCV81K/D1PNOC5	OCV81K/D1PNOM	OCV81K/D1PNOMC5
PNP NC	OCV81K/D1PNC	OCV81K/D1PNCC5	OCV81K/D1PNCM	OCV81K/D1PNCMC5
NPN NO	OCV81K/D1NNO	OCV81K/D1NNOC5	OCV81K/D1NNOM	OCV81K/D1NNOMC5
NPN NC	OCV81K/D1NNC	OCV81K/D1NNCC5	OCV81K/D1NNCM	OCV81K/D1NNCMC5

**MODELLO D1 - Sn = 200 mm - REGOLABILE**
**D1 TYPE - Sn = 200 mm - ADJUSTABLE**

USCITA/OUTPUT	PLASTICA / PLASTIC		METALLICA / METAL	
	CAVO/CABLE	CONNETTORE/CONNECTOR	CAVO/CABLE	CONNETTORE/CONNECTOR
PNP NO	OCV81K/D1PNOR	-	OCV81K/D1PNORM	OCV81K/D1PNORMC5
PNP NC	OCV81K/D1PNCR	-	OCV81K/D1PNCRM	OCV81K/D1PNCRM5
NPN NO	OCV81K/D1NNOR	-	OCV81K/D1NNORM	OCV81K/D1NNORMC5
NPN NC	OCV81K/D1NNCR	-	OCV81K/D1NNCRM	OCV81K/D1NNCRM5

**TASTEGGIO RADIALE  
ALTE FREQUENZE 10 kHz**
**RADIAL DIFFUSE TYPE  
10 kHz WORKING FREQUENCY**
**ELENCO PRODOTTI      ALTE FREQUENZE 10 kHz / 10 kHz HIGH FREQUENCY      PRODUCTS LIST  
OTTICA RADIALE      /      RADIAL OPTICAL**
**MODELLO D - Sn = 100 mm**
**D TYPE - Sn = 100 mm**

USCITA/OUTPUT	PLASTICA / PLASTIC		METALLICA / METAL	
	CAVO / CABLE	CONNETTORE/CONNECTOR	CAVO / CABLE	CONNETTORE/CONNECTOR
PNP NO	OCV81K/DAPNO	OCV81K/DAPNOC5	OCV81K/DAPNOM	OCV81K/DAPNOMC5
PNP NC	OCV81K/DAPNC	OCV81K/DAPNCC5	OCV81K/DAPNCM	OCV81K/DAPNCMC5
NPN NO	OCV81K/DANNO	OCV81K/DANNOC5	OCV81K/DANNOM	OCV81K/DANNOMC5
NPN NC	OCV81K/DANNC	OCV81K/DANNCC5	OCV81K/DANNCM	OCV81K/DANNCMC5

**MODELLO D1 - Sn = 200 mm**
**D1 TYPE - Sn = 200 mm**

USCITA/OUTPUT	PLASTICA/PLASTIC		METALLICA/METAL	
	CAVO/CABLE	CONNETTORE/CONNECTOR	CAVO/CABLE	CONNETTORE/CONNECTOR
PNP NO	OCV81K/D1APNO	OCV81K/D1APNOC5	OCV81K/D1APNOM	OCV81K/D1APNOMC5
PNP NC	OCV81K/D1APNC	OCV81K/D1APNCC5	OCV81K/D1APNCM	OCV81K/D1APNCMC5
NPN NO	OCV81K/D1ANNO	OCV81K/D1ANNOC5	OCV81K/D1ANNOM	OCV81K/D1ANNOMC5
NPN NC	OCV81K/D1ANNC	OCV81K/D1ANNCC5	OCV81K/D1ANNCM	OCV81K/D1ANNCMC5

**MODELLO D1 - Sn = 200 mm - REGOLABILE**
**D1 TYPE - Sn = 200 mm - ADJUSTABLE**

USCITA/OUTPUT	PLASTICA / PLASTIC		METALLICA / METAL	
	CAVO/CABLE	CONNETTORE/CONNECTOR	CAVO/CABLE	CONNETTORE/CONNECTOR
PNP NO	OCV81K/D1APNOR	-	OCV81K/D1APNORM	OCV81K/D1APNORMC5
PNP NC	OCV81K/D1APNCR	-	OCV81K/D1APNCRM	OCV81K/D1APNCRM5
NPN NO	OCV81K/D1ANNOR	-	OCV81K/D1ANNORM	OCV81K/D1ANNORMC5
NPN NC	OCV81K/D1ANNCR	-	OCV81K/D1ANNCRM	OCV81K/D1ANNCRM5

**RIFERIMENTI CONNETTORI PARTE VOLANTE**
**CONNECTOR LOOSE PART CODES**

FEMMINA / FEMALE	DIRITTO/STRAIGHT	90° / DEGREES ANGLED CABLE OUTPUT	M12
CABLE / CABLE	L70500	C70500	3 POLI / 3 POLES
CEI 20-22 II - L= 5 m	L90500	C90500	4 POLI / 4 POLES

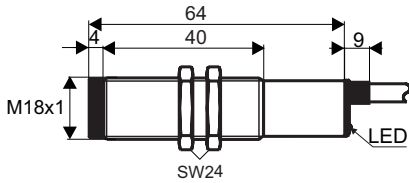
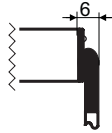
**TASTEGGIO DIRETTO**
**DIFFUSE TYPE**
**DIMENSIONI MECCANICHE**
**OTTICA ASSIALE / ASSIAL OPTICAL**
**MECHANICAL SIZE**
**CONTENITORE METALLICO / METAL BODY**
**CONTENITORE PLASTICO / PLASTIC BODY**
**VERSIONE NON REGOLABILE**
**FIXED VERSION**

 USCITA CAVO 90°  
90 DEGREES ANGLED  
CABLE OUTPUT

 VISTA PARTE SENSIBILE  
SENSITIVE SIDE VIEW

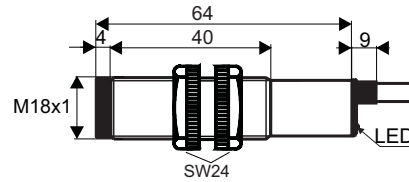
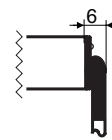
 VISTA USCITA CAVO  
CABLE OUTPUT VIEW

 VISTA USCITA CAVO 90°  
90 DEGREES ANGLED  
CABLE OUTPUT VIEW

**VERSIONE NON REGOLABILE**
**FIXED VERSION**

 USCITA CAVO 90°  
90 DEGREES ANGLED  
CABLE OUTPUT

 VISTA PARTE SENSIBILE  
SENSITIVE SIDE VIEW

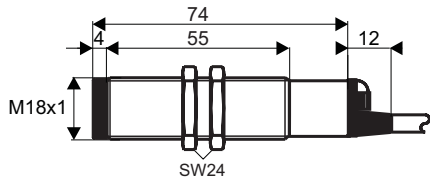
 VISTA USCITA CAVO  
CABLE OUTPUT VIEW

 VISTA USCITA CAVO 90°  
90 DEGREES ANGLED  
CABLE OUTPUT VIEW

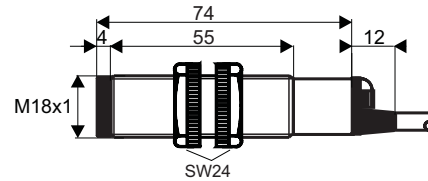
**VERSIONE REGOLABILE**
**ADJUSTABLE VERSION**

 VISTA PARTE SENSIBILE  
SENSITIVE SIDE VIEW

 VISTA USCITA CAVO  
CABLE OUTPUT VIEW

**VERSIONE REGOLABILE**
**ADJUSTABLE VERSION**

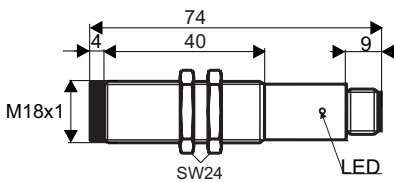
 VISTA PARTE SENSIBILE  
SENSITIVE SIDE VIEW

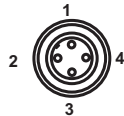
 VISTA USCITA CAVO  
CABLE OUTPUT VIEW

**VERSIONE NON REGOLABILE**
**FIXED VERSION**

 VISTA PARTE SENSIBILE  
SENSITIVE SIDE VIEW

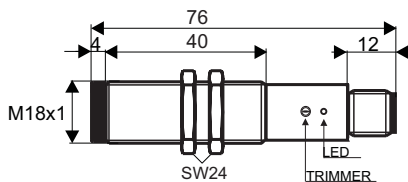
 VISTA USCITA CONNETTORE M12  
M12 CONNECTOR OUTPUT VIEW

 VISTA PARTE SENSIBILE  
SENSITIVE SIDE VIEW

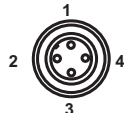
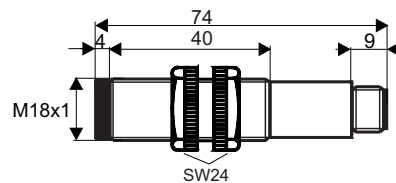
 VISTA USCITA CAVO  
CABLE OUTPUT VIEW

**VERSIONE REGOLABILE**
**ADJUSTABLE VERSION**

 VISTA PARTE SENSIBILE  
SENSITIVE SIDE VIEW

 VISTA USCITA CONNETTORE M12  
M12 CONNECTOR OUTPUT VIEW

**VERSIONE NON REGOLABILE**
**FIXED VERSION**

 VISTA PARTE SENSIBILE  
SENSITIVE SIDE VIEW

 VISTA USCITA CONNETTORE M12  
M12 CONNECTOR OUTPUT VIEW

**TASTEGGIO DIRETTO RADIALE**

*RADIAL DIFFUSE TYPE*

**DIMENSIONI MECCANICHE      OTTICA RADIALE/ RADIAL OPTICAL      MECHANICAL SIZE**

**CONTENITORE METALLICO / METAL BODY**

**CONTENITORE PLASTICO / PLASTIC BODY**

**VERSIONE NON REGOLABILE      FIXED VERSION**

**VERSIONE NON REGOLABILE      FIXED VERSION**

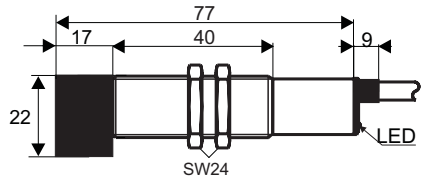

VISTA PARTE SENSIBILE  
SENSITIVE SIDE VIEW

VISTA USCITA CAVO  
CABLE OUTPUT VIEW

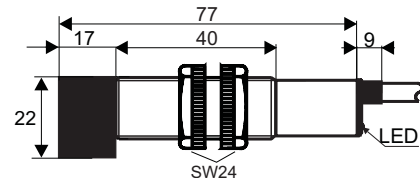

VISTA PARTE SENSIBILE  
SENSITIVE SIDE VIEW

VISTA USCITA CAVO  
CABLE OUTPUT VIEW



**VERSIONE REGOLABILE      ADJUSTABLE VERSION**

**VERSIONE REGOLABILE      ADJUSTABLE VERSION**

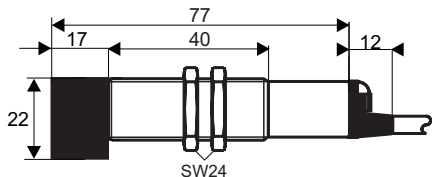

VISTA PARTE SENSIBILE  
SENSITIVE SIDE VIEW

VISTA USCITA CAVO  
CABLE OUTPUT VIEW

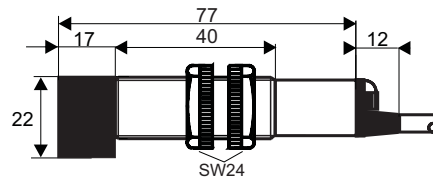

VISTA PARTE SENSIBILE  
SENSITIVE SIDE VIEW

VISTA USCITA CAVO  
CABLE OUTPUT VIEW



**VERSIONE NON REGOLABILE      FIXED VERSION**

**VERSIONE NON REGOLABILE      FIXED VERSION**

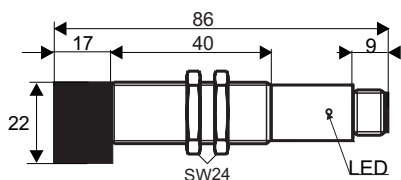

VISTA PARTE SENSIBILE  
SENSITIVE SIDE VIEW

VISTA USCITA CONNETTORE M12  
M12 CONNECTOR OUTPUT VIEW

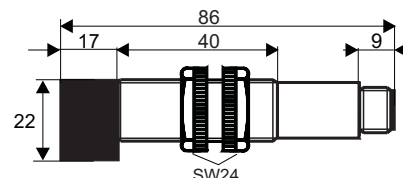
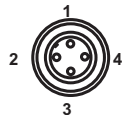

VISTA PARTE SENSIBILE  
SENSITIVE SIDE VIEW

VISTA USCITA CONNETTORE M12  
M12 CONNECTOR OUTPUT VIEW

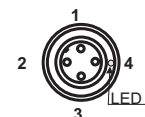

**VERSIONE REGOLABILE      ADJUSTABLE VERSION**

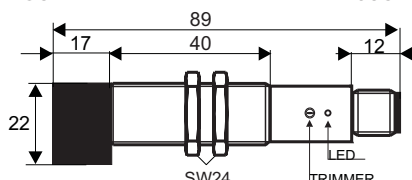

VISTA PARTE SENSIBILE  
SENSITIVE SIDE VIEW

VISTA USCITA CONNETTORE M12  
M12 CONNECTOR OUTPUT VIEW

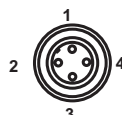



**Altri prodotti**

- interruttori di prossimità induttivi;
- interruttori di prossimità capacitivi;
- interruttori di prossimità magnetici;
- interruttori di prossimità fotoelettrici;
  
- connettori e cassette di connessione per sensori;
  
- encoder incrementali ed assoluti;
  
- alimentatori / interfacce per sensori;
- alimentatori da rete e da secondario per uso generico;
  
- voltmetri, amperometri, contagiri, visualizzatori a pannello;
- contaimpulsi mono e bidirezionali, contaproduzione, contagiri;
- termometri e termoregolatori
  
- schede logiche programmabili per uso OEM;
  
- pulsanteria e finecorsa meccanici;

***Other products:***

- *inductive proximity switches;*
- *capacitive proximity switches;*
- *magnetic proximity switches;*
- *photo-electric sensors & proximity switches;*
  
- *connectors & connection boxes for sensor;*
  
- *incremental & absolute encoders;*
  
- *supply units / interfaces for sensors;*
- *power supply units for general purpose;*
  
- *voltmeters, ammeters, revolution counters, panel displays;*
- *counters mono & bi-directional, timers, revolution counters;*
- *thermometers & temperature controllers;*
  
- *OEM programmable logic cards;*
  
- *push-button & mechanical limit switches;*