

**Part number: YC8000047 - Model: SC18SM-CE10 NPN NO+NC AD3 LC5**

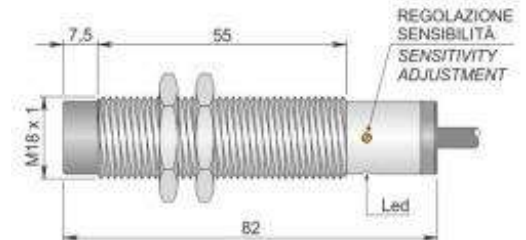

Dimension in mm

### TECHNICAL CHARACTERISTICS

Working voltage:	10 ÷ 30 Vdc
Output type:	DC NPN
Function:	NO+NC
Actuation type:	Instantaneous
Sensing distance (mm):	0 ÷ 10 (adjustable)
Hysteresis (%):	Depends on the switching distance
Max. switching frequency:	10 Hz
Repeatability (%Sn):	< 10
Max. output current:	200 mA
Absorption:	< = 10 mA @ 24Vdc
Voltage drop:	< 1.8 V
Short circuit protection:	Present
Led indicator:	Present
Shielded:	Not embeddable
Mechanical characteristics:	M18X1
IP rating:	IP 67
Housing material:	Nickelled brass
Connection type:	Cable 5 m
Cable type:	4x0.25 PVC shielded
Weight:	210 g
Operating temperature range:	-25 ÷ +60 °C
Storage temperature range:	-25 ÷ +70 °C
Max. surface temperature:	+85 °C
Limiting device of surface temperature:	Intervention at 75 ° C non-resettable
Explosive atmosphere type:	Air/Dust mixture
Equipment category:	3D
Installation area:	Zone 22
Protection method:	Protection by enclosure
Marking:	II 3D Ex tc IIIC T85°C Dc X-25< Ta
Conforming standard:	EN60079-0, EN60079-31, EN61000-6-2, EN61000-6-4 and EN60947-5-2

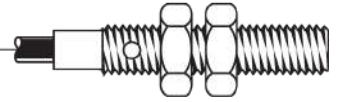

**Part number: YC800047 - Model: SC18SM-CE10 NPN NO+NC AD3 LC5**

**WIRING DIAGRAM**

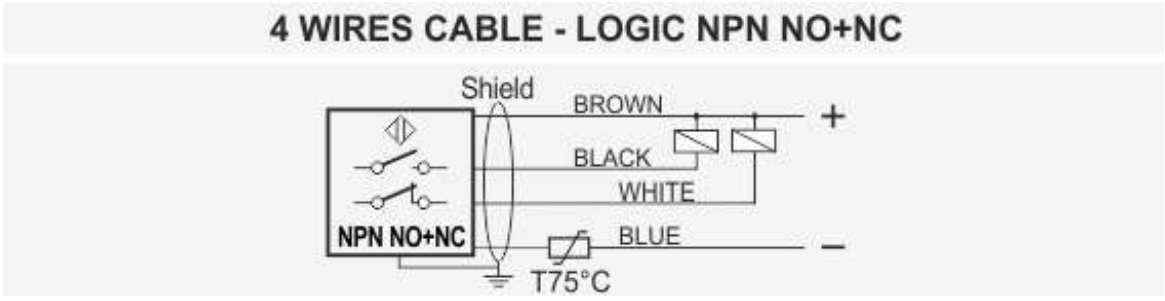

**INSTRUCTIONS FOR CORRECT INSTALLATION**

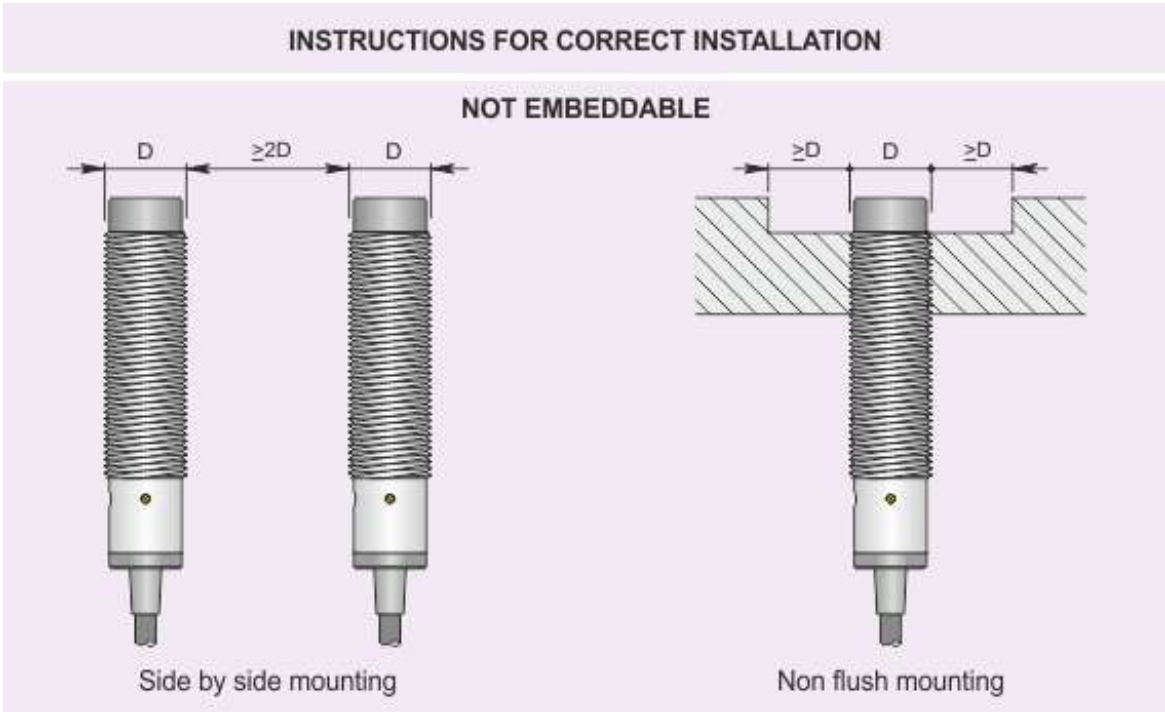

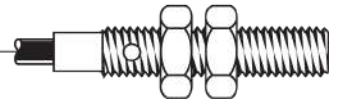

**Part number: YC8000008 - Model: SC18SM-CE10 PNP NO+NC AD3**

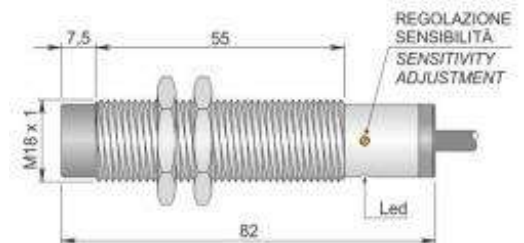

Dimension in mm

### TECHNICAL CHARACTERISTICS

Working voltage:	10 ÷ 30 Vdc
Output type:	DC PNP
Function:	NO+NC
Actuation type:	Instantaneous
Sensing distance (mm):	0 ÷ 10 (adjustable)
Hysteresis (%):	Depends on the switching distance
Max. switching frequency:	10 Hz
Repeatability (%Sn):	< 10
Max. output current:	200 mA
Absorption:	< = 10 mA @ 24Vdc
Voltage drop:	< 1.8 V
Short circuit protection:	Present
Led indicator:	Present
Shielded:	Not embeddable
Mechanical characteristics:	M18X1
IP rating:	IP 67
Housing material:	Nickelled brass
Connection type:	Cable 3 m
Cable type:	4x0.25 PVC shielded
Weight:	140 g
Operating temperature range:	-25 ÷ +60 °C
Storage temperature range:	-25 ÷ +70 °C
Max. surface temperature:	+85 °C
Limiting device of surface temperature:	Intervention at 75 ° C non-resettable
Explosive atmosphere type:	Air/Dust mixture
Equipment category:	3D
Installation area:	Zone 22
Protection method:	Protection by enclosure
Marking:	II 3D Ex tc IIIC T85°C Dc X-25< Ta
Conforming standard:	EN60079-0, EN60079-31, EN61000-6-2, EN61000-6-4 and EN60947-5-2

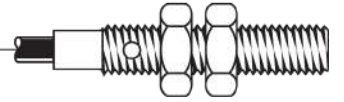

**Part number: YC800008 - Model: SC18SM-CE10 PNP NO+NC AD3**

**WIRING DIAGRAM**

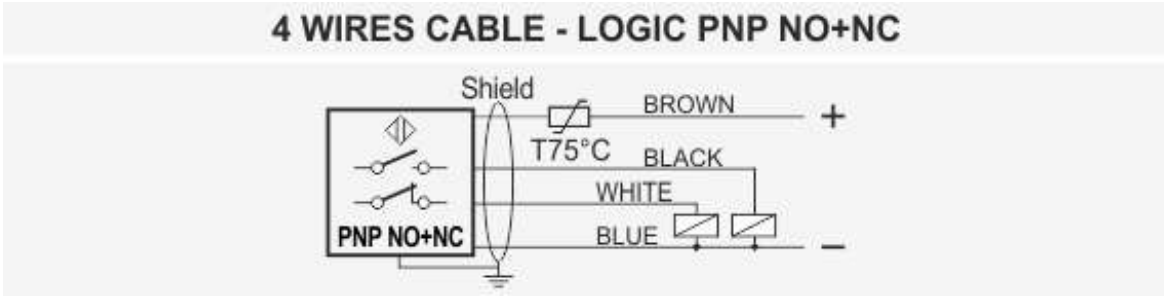

**INSTRUCTIONS FOR CORRECT INSTALLATION**

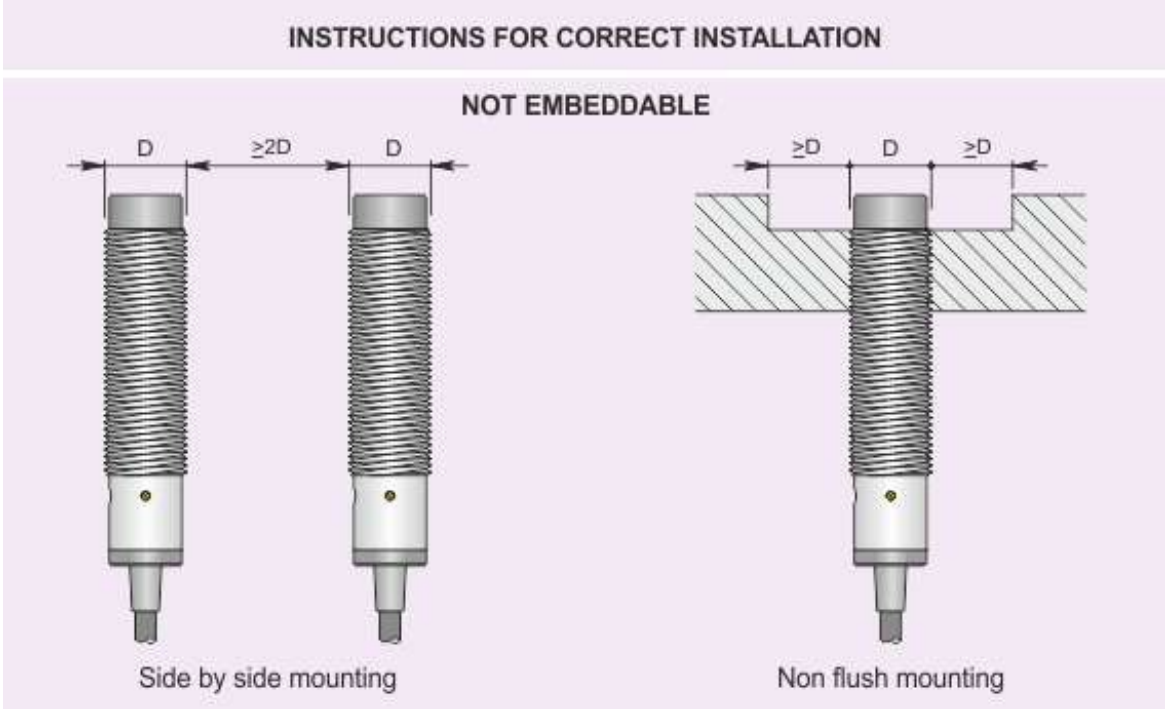

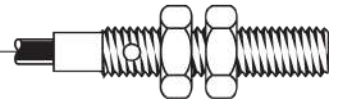

**Part number: YC8000046 - Model: SC18SM-CE10 PNP NO+NC AD3 LC5**

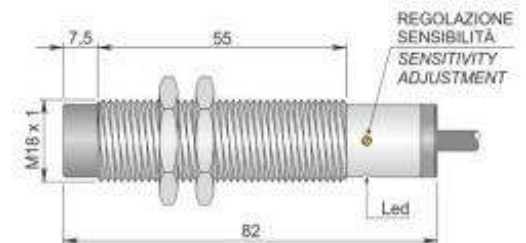

Dimension in mm

### TECHNICAL CHARACTERISTICS

Working voltage:	10 ÷ 30 Vdc
Output type:	DC PNP
Function:	NO+NC
Actuation type:	Instantaneous
Sensing distance (mm):	0 ÷ 10 (adjustable)
Hysteresis (%):	Depends on the switching distance
Max. switching frequency:	10 Hz
Repeatability (%Sn):	< 10
Max. output current:	200 mA
Absorption:	< = 10 mA @ 24Vdc
Voltage drop:	< 1.8 V
Short circuit protection:	Present
Led indicator:	Present
Shielded:	Not embeddable
Mechanical characteristics:	M18X1
IP rating:	IP 67
Housing material:	Nickelled brass
Connection type:	Cable 5 m
Cable type:	4x0.25 PVC shielded
Weight:	210 g
Operating temperature range:	-25 ÷ +60 °C
Storage temperature range:	-25 ÷ +70 °C
Max. surface temperature:	+85 °C
Limiting device of surface temperature:	Intervention at 75 ° C non-resettable
Explosive atmosphere type:	Air/Dust mixture
Equipment category:	3D
Installation area:	Zone 22
Protection method:	Protection by enclosure
Marking:	II 3D Ex tc IIIC T85°C Dc X-25< Ta
Conforming standard:	EN60079-0, EN60079-31, EN61000-6-2, EN61000-6-4 and EN60947-5-2

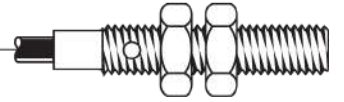

**Part number: YC8000046 - Model: SC18SM-CE10 PNP NO+NC AD3 LC5**

**WIRING DIAGRAM**

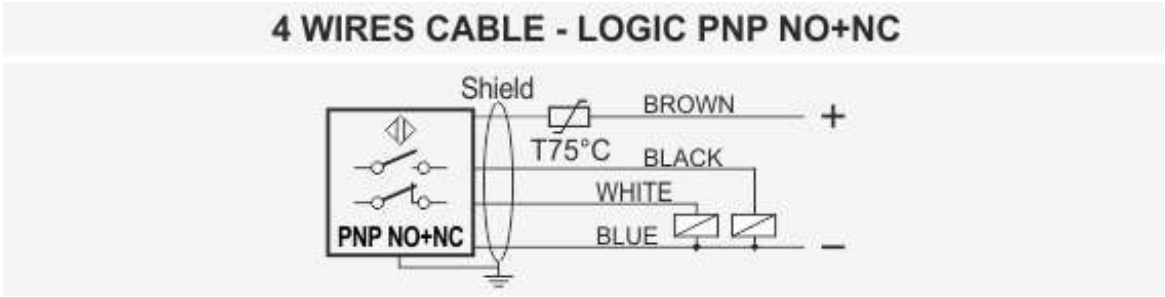

**INSTRUCTIONS FOR CORRECT INSTALLATION**

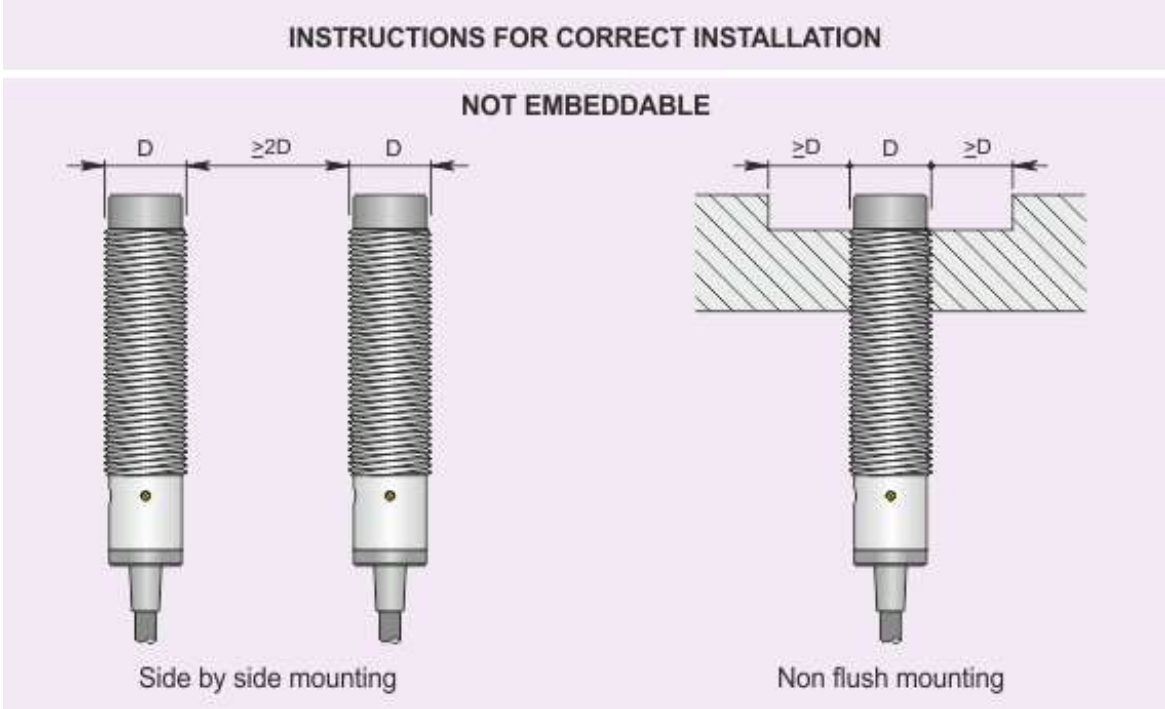

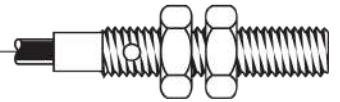

**Part number: YC8000017 - Model: SC18SM-CE10 PNP NO+NCAD3 LC10**

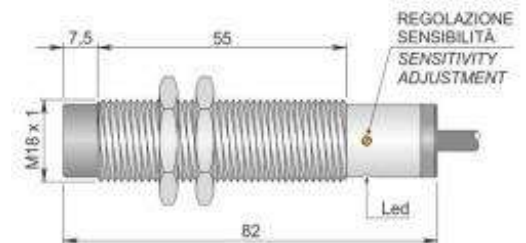

Dimension in mm

### TECHNICAL CHARACTERISTICS

Working voltage:	10 ÷ 30 Vdc
Output type:	DC PNP
Function:	NO+NC
Actuation type:	Instantaneous
Sensing distance (mm):	0 ÷ 10 (adjustable)
Hysteresis (%):	Depends on the switching distance
Max. switching frequency:	10 Hz
Repeatability (%Sn):	< 10
Max. output current:	200 mA
Absorption:	< = 10 mA @ 24Vdc
Voltage drop:	< 1.8 V
Short circuit protection:	Present
Led indicator:	Present
Shielded:	Not embeddable
Mechanical characteristics:	M18X1
IP rating:	IP 67
Housing material:	Nickelled brass
Connection type:	Cable 10 m
Cable type:	4x0.25 PVC shielded
Weight:	450 g
Operating temperature range:	-25 ÷ +60 °C
Storage temperature range:	-25 ÷ +70 °C
Max. surface temperature:	+85 °C
Limiting device of surface temperature:	Intervention at 75 ° C non-resettable
Explosive atmosphere type:	Air/Dust mixture
Equipment category:	3D
Installation area:	Zone 22
Protection method:	Protection by enclosure
Marking:	II 3D Ex tc IIIC T85°C Dc X-25< Ta
Conforming standard:	EN60079-0, EN60079-31, EN61000-6-2, EN61000-6-4 and EN60947-5-2

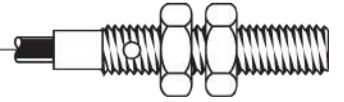

Part number: YC8000017 - Model: SC18SM-CE10 PNP NO+NCAD3 LC10

## WIRING DIAGRAM

### 4 WIRES CABLE - LOGIC PNP NO+NC

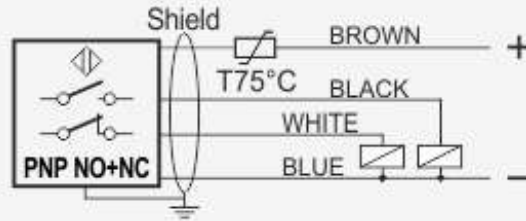

## INSTRUCTIONS FOR CORRECT INSTALLATION

### INSTRUCTIONS FOR CORRECT INSTALLATION

#### NOT EMBEDDABLE



Side by side mounting

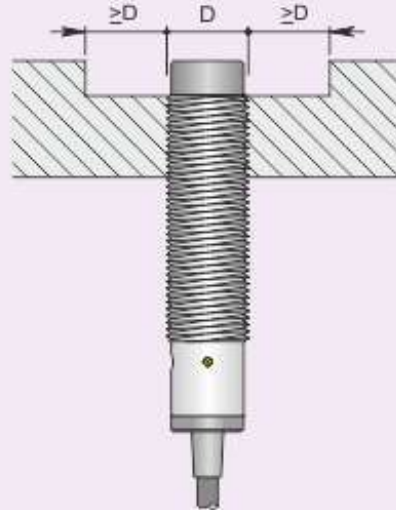

Non flush mounting



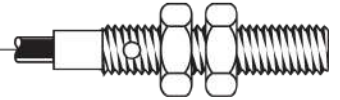

**Part number: YC800007 - Model: SC18SM-CE10 NPN NO+NC AD3**

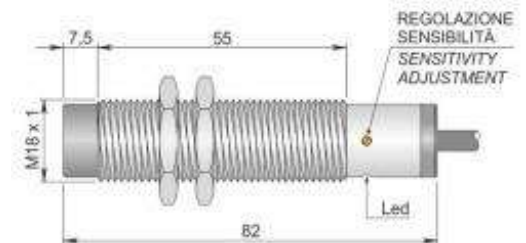

Dimension in mm

**TECHNICAL CHARACTERISTICS**

Working voltage:	10 ÷ 30 Vdc
Output type:	DC NPN
Function:	NO+NC
Actuation type:	Instantaneous
Sensing distance (mm):	0 ÷ 10 (adjustable)
Hysteresis (%):	Depends on the switching distance
Max. switching frequency:	10 Hz
Repeatability (%Sn):	< 10
Max. output current:	200 mA
Absorption:	< = 10 mA @ 24Vdc
Voltage drop:	< 1.8 V
Short circuit protection:	Present
Led indicator:	Present
Shielded:	Not embeddable
Mechanical characteristics:	M18X1
IP rating:	IP 67
Housing material:	Nickelled brass
Connection type:	Cable 3 m
Cable type:	4x0.25 PVC shielded
Weight:	140 g
Operating temperature range:	-25 ÷ +60 °C
Storage temperature range:	-25 ÷ +70 °C
Max. surface temperature:	+85 °C
Limiting device of surface temperature:	Intervention at 75 ° C non-resettable
Explosive atmosphere type:	Air/Dust mixture
Equipment category:	3D
Installation area:	Zone 22
Protection method:	Protection by enclosure
Marking:	II 3D Ex tc IIIC T85°C Dc X-25< Ta
Conforming standard:	EN60079-0, EN60079-31, EN61000-6-2, EN61000-6-4 and EN60947-5-2

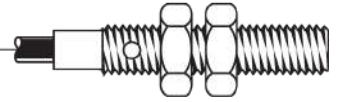

Part number: YC800007 - Model: SC18SM-CE10 NPN NO+NC AD3

## WIRING DIAGRAM

### 4 WIRES CABLE - LOGIC NPN NO+NC

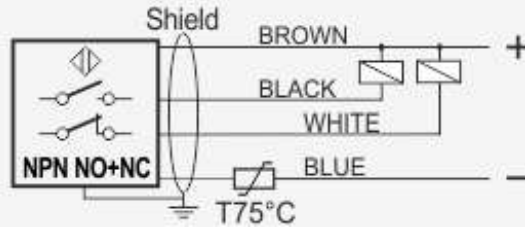

## INSTRUCTIONS FOR CORRECT INSTALLATION

### INSTRUCTIONS FOR CORRECT INSTALLATION

#### NOT EMBEDDABLE

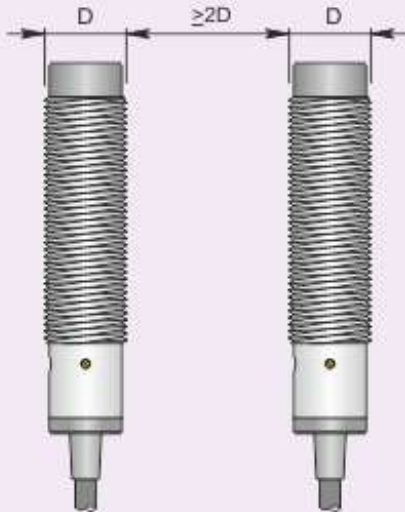

Side by side mounting

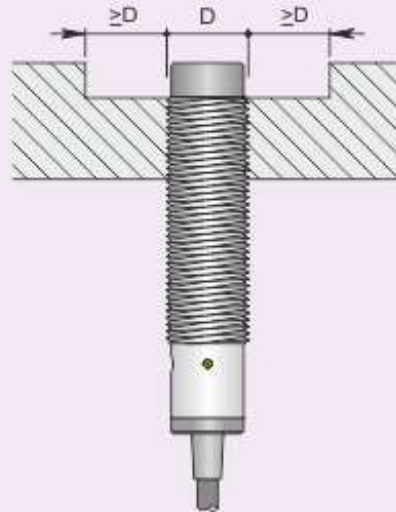

Non flush mounting

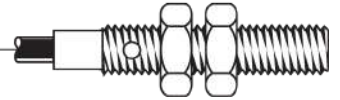

**Part number: YC800048 - Model: SC18SM-CE10 NPN NO+NC AD3 LC10**

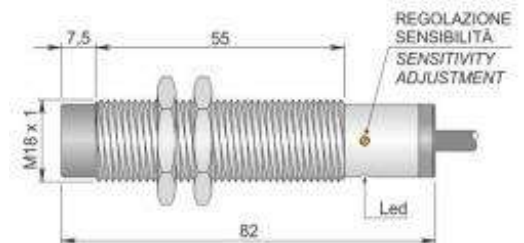

Dimension in mm

### TECHNICAL CHARACTERISTICS

Working voltage:	10 ÷ 30 Vdc
Output type:	DC NPN
Function:	NO+NC
Actuation type:	Instantaneous
Sensing distance (mm):	0 ÷ 10 (adjustable)
Hysteresis (%):	Depends on the switching distance
Max. switching frequency:	10 Hz
Repeatability (%Sn):	< 10
Max. output current:	200 mA
Absorption:	< = 10 mA @ 24Vdc
Voltage drop:	< 1.8 V
Short circuit protection:	Present
Led indicator:	Present
Shielded:	Not embeddable
Mechanical characteristics:	M18X1
IP rating:	IP 67
Housing material:	Nickelled brass
Connection type:	Cable 10 m
Cable type:	4x0.25 PVC shielded
Weight:	450 g
Operating temperature range:	-25 ÷ +60 °C
Storage temperature range:	-25 ÷ +70 °C
Max. surface temperature:	+85 °C
Limiting device of surface temperature:	Intervention at 75 ° C non-resettable
Explosive atmosphere type:	Air/Dust mixture
Equipment category:	3D
Installation area:	Zone 22
Protection method:	Protection by enclosure
Marking:	II 3D Ex tc IIIC T85°C Dc X-25< Ta
Conforming standard:	EN60079-0, EN60079-31, EN61000-6-2, EN61000-6-4 and EN60947-5-2

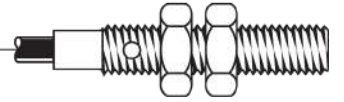

Part number: YC800048 - Model: SC18SM-CE10 NPN NO+NC AD3 LC10

## WIRING DIAGRAM

### 4 WIRES CABLE - LOGIC NPN NO+NC

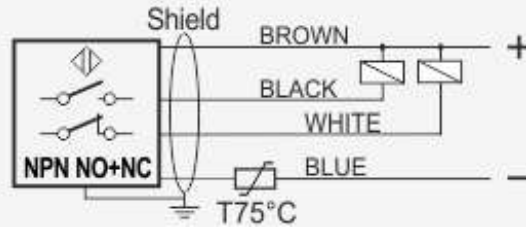

## INSTRUCTIONS FOR CORRECT INSTALLATION

### INSTRUCTIONS FOR CORRECT INSTALLATION

#### NOT EMBEDDABLE



Side by side mounting

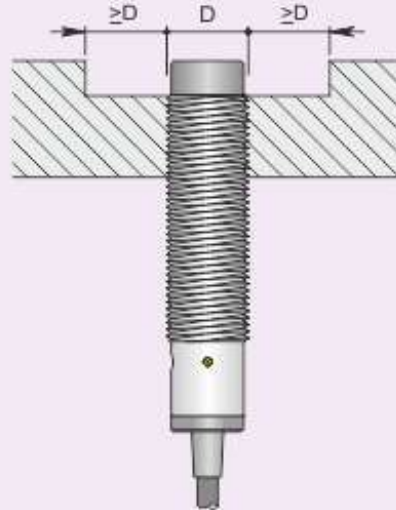

Non flush mounting