



OF/OFA series

Complete range of optic fibers: universal or advanced models

- Flexible models
- High temperature models (up to 125 °C)
- Fiber array with parallel beams for proximity or through beam detection
- Fixed focus proximity with axial, radial or lateral optics
- Proximity with 90° optics self-contained
- Focusing, collimating and deviating lenses



SENSORS



OF/OFA	
Through beam	Mechanical characteristics, length, diameter of the optic fiber, as well as the switching frequencies, light emitted and resolution of the optic fiber amplifier, affect the operating distances. Refer to the manuals to find the proper operating distance.
Diffuse proximity	
Fixed focus	
OF diameter	M3, M4, M6
OFA number of emitted beams	1, 16, 32
Cable lengths	1, 2 m
Operating temperature	-40...+60 °C (OF) -40...125 °C (OF-...-HT) -30...+70 °C (OFA)
Core material	PMMA plastic
Sheath material	PE plastic
Terminal material	Nickel-plated brass (OF), Stainless steel, Aluminium, ABS (OFA)
Mechanical protection	IP67

OF series					
OPTIC FUNCTION	FIBER TYPE	LENGTH	TERMINAL	MODEL	ORDER No.
Through beam	standard	1 m	M4x0.7 mm	OF-19-ST-10	S76021901
	standard	2 m	M4x0.7 mm *	OF-23-ST-20	S76022300
	thin (Ø 1 mm)	1 m	M2x0.4 mm	OF-25-TN-10	S76022500
	standard	2 m	M4x0.7 mm	OF-43-ST-20	95A201350
	high-temperature	2 m	M4x0.7 mm	OF-43-HT-20	95A201280
	ultra-flexible	2 m	M4x0.7 mm	OF-43-UF-20	95A201290
	high-efficiency	2 m	M4x0.7 mm	OF-43-HP-20	95A201300
Proximity	standard	1 m	M6x1 mm	OF-18-ST-10	S76021801
	standard	2 m	M6x1 mm *	OF-22-ST-20	S76022200
	standard	2 m	M4x0.7 mm	OF-24-ST-20	S76022400
	thin (Ø 1 mm)	1 m	M3x0.5 mm	OF-26-TN-10	S76022600
	thin (Ø 1 mm)	1 m	M3x0.5 mm *	OF-28-TN-10	S76022800
	standard	2 m	Ø 3x15 mm	OF-38-ST-20	95A201070
	standard	2 m	M6x0.75 mm	OF-42-ST-20	95A201340
	high-temperature	2 m	M6x0.75 mm	OF-42-HT-20	95A201250
	ultra-flexible	2 m	M6x0.75 mm	OF-42-UF-20	95A201260
	high-efficiency	2 m	M6x0.75 mm	OF-42-HP-20	95A201270
Coaxial proximity	standard	2 m	M6x1 mm	OF-36-ST-20	95A201000
	extra-flexible	2 m	M6x1 mm	OF-36-XF-20	95A201330
	standard	2 m	M4x0.7 mm	OF-44-ST-20	95A201310
	extra-flexible	2 m	M4x0.7 mm	OF-44-XF-20	95A201320

* a bendable stainless steel extension 90mm long protrudes from the threaded optic head



OFA series					
OPTIC FUNCTION	FIBER TYPE	LENGTH	TERMINAL	MODEL	ORDER No.
Through beam	axial, 16 beam array	2 m	15x15 mm	OFA-1-AE-20	95A201170
	radial, 16 beam array	2 m	15x15 mm	OFA-1-AS-20	95A201180
Proximity	axial, 32 beam array	2 m	20x20 mm	OFA-2-AE-20	95A201150
	radial, 32 beam array	2 m	20x20 mm	OFA-2-AS-20	95A201160
	radial	2 m	5x65 mm	OFA-6-RA-20	95A201140
Fixed focus proximity	axial	2 m	15x20 mm	OFA-4-FE-20	95A201200
	lateral	2 m	15x20 mm	OFA-4-FF-20	95A201210
	radial	2 m	15x20 mm	OFA-4-FS-20	95A201190



OF Accessories			
DESCRIPTION	SUITABLE FiberS	MODEL	CODE N°
2 pcs 90° deviating lenses	OF-43-XX	AF-1	95ACC2690
2 pcs long distance collimating lenses (x 4)	OF-43-XX	AF-2	95ACC2700
1 pc focusing lens with 4 mm resolution	OF-44-XX	AF-3	95ACC2710
1 pc focusing lens with 0.4 mm resolution	OF-44-XX	AF-4	95ACC2720
2 pcs adapters Ø 2.2 mm for thin Fibers	OF-XX-TN	AF-5	95ACC2730
1 pc metal sheath for m6 x 0.75 Fibers	OF-42-XX	AF-7	95ACC2750
1 pc metal sheath for m4 x 07 Fibers	OF-43-XX (*)	AF-9	95ACC2770
Fiber-cutting tool with Ø 2.2 mm and Ø 1.1 mm holes	ALL	AF-11	95ACC2780

* 2 sheaths have to be ordered for both the emitter-receiver sections

DIMENSIONS

OF SERIES

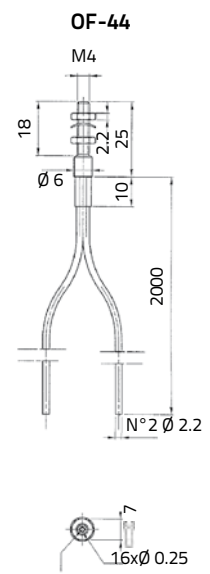
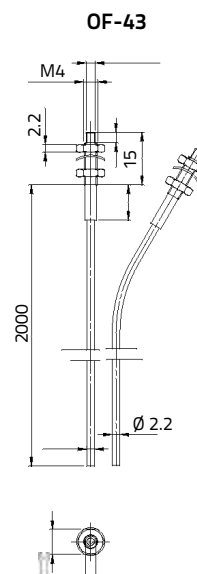
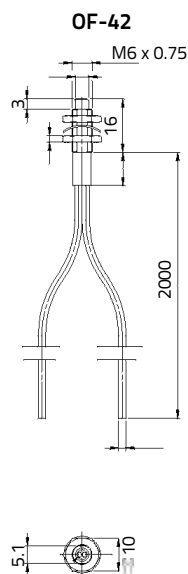
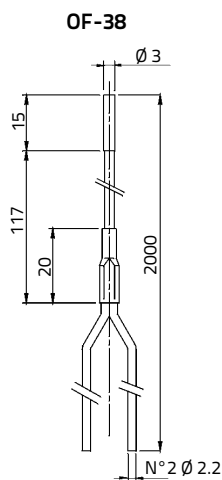
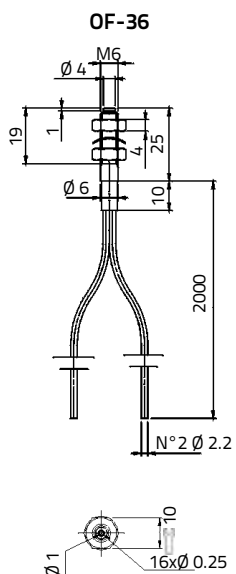
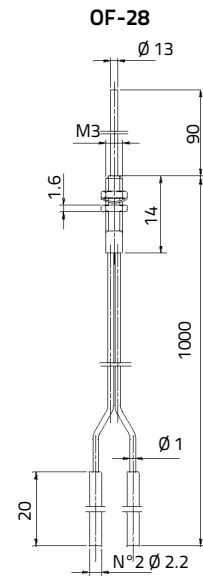
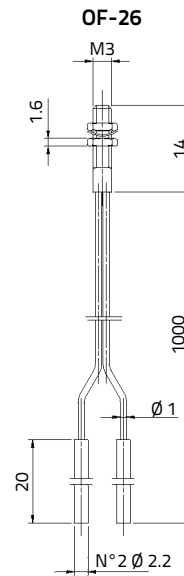
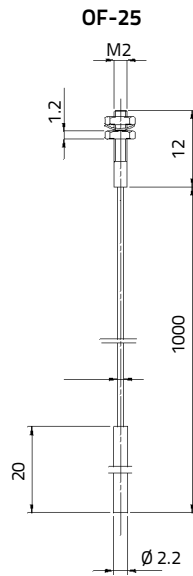
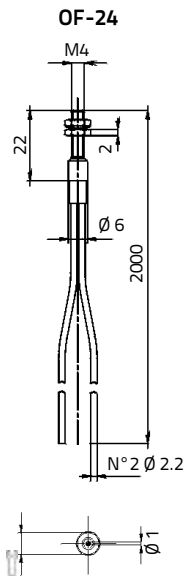
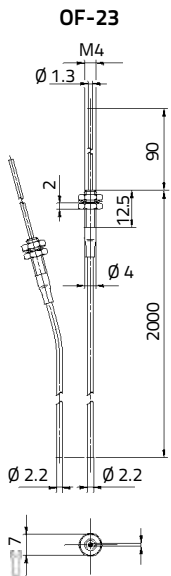
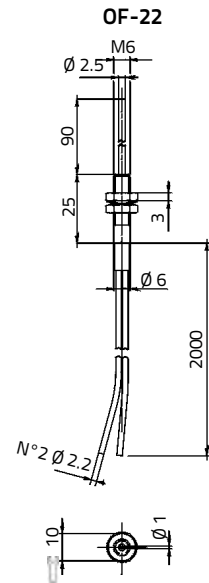
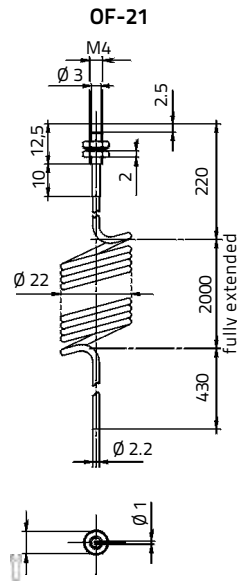
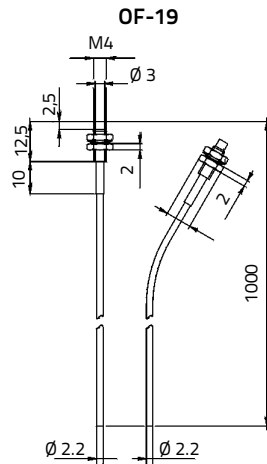
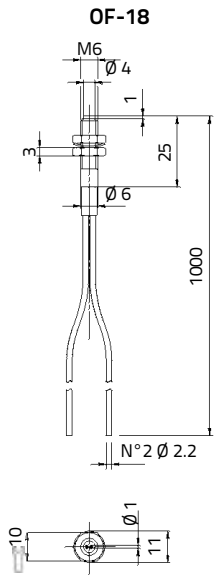

mm

DIMENSIONS

OFA SERIES

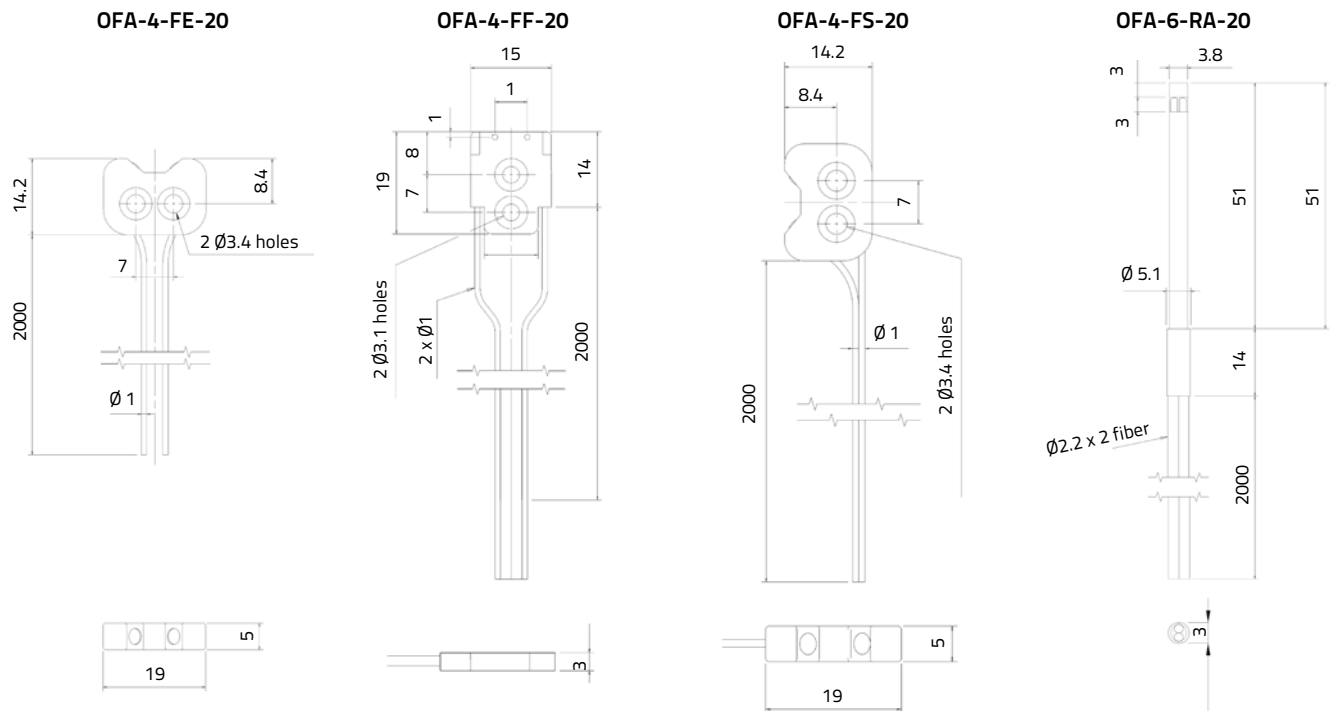
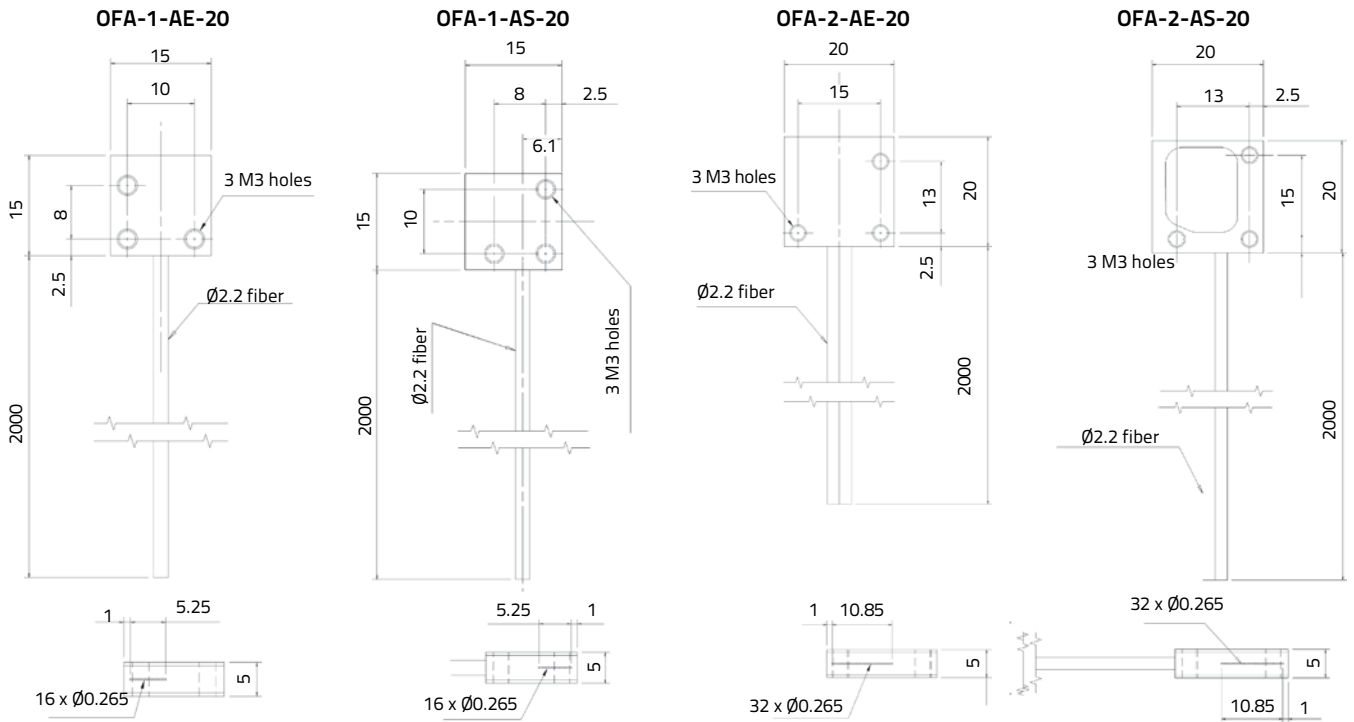

mm

DETECTION DIAGRAMS

