

VARIMETER

Frequency Relay
BA 9837, AA 9837, AA 9838

Translation
of the original instructions

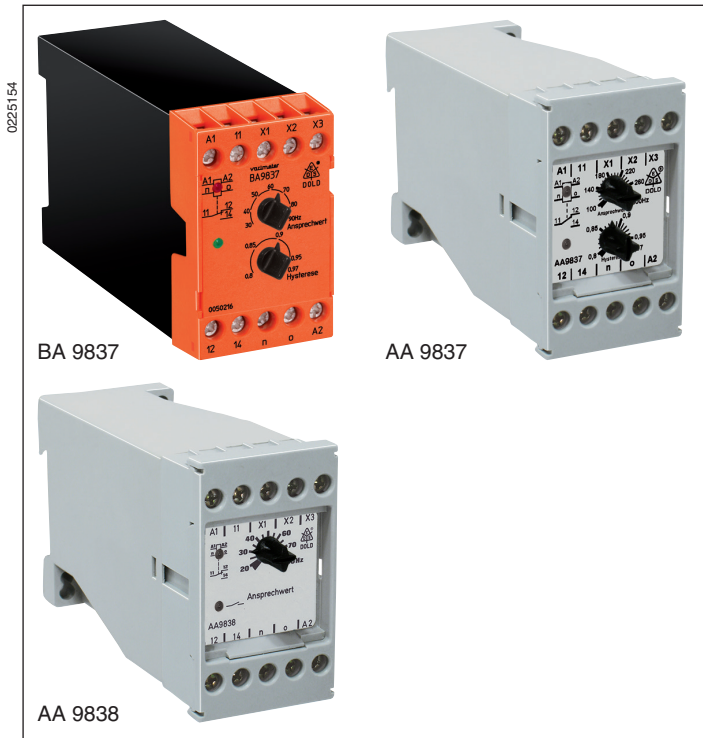

- According IEC/EN 60255-1
- Detection of under- or overfrequency
- Adjustable response value
- Optionally 1 or 2 changeover contacts
- Width 45 mm

Approvals and Markings



Application

The frequency relay can be used especially in applications where the rotor frequency of a slip-ring motor must be measured. The rotor frequency is reciprocal proportional to the speed (see diagram rotor frequency at contercurrent braking). This behaviour allows to find speed depending switching values and can be used for start up and contercurrent braking of motors on cranes.

Function Diagram

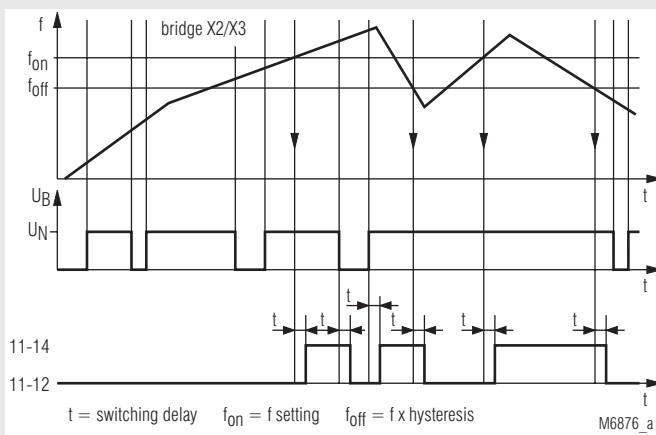
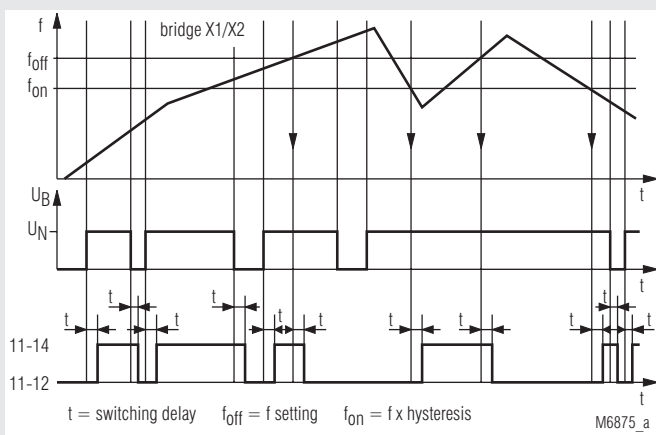

Function

The device compares 2 frequencies. The measuring frequency is compared to an internally generated, settable frequency reference.

With bridge on X1-X2 the output relay deenergises when the measuring frequency is higher then the setted frequency. The relay energises again when the measuring frequency drops under the setted frequency x hysteresis.

With bridge on X2-X3 the output relay energises when the measuring frequency is higher then the setted frequency. The relay deenergises again when the measuring frequency drops under the setted frequency x hysteresis.

An indicating LED shows that the frequency signal is connected. At low frequency the LED flashes. A second LED indicates the state of the output relay.

Notes

Terminals X1, X2, X3 should only be connected together with the corresponding wire links. Do not connect external voltage, neutral or ground. The measuring input is designed for an amplitude of AC 8...500 V. Higher values AC 12...800 V can be achieved by connecting a series resistor, type IK 5110 into the measuring circuit either to terminal n or o.

Circuit Diagrams

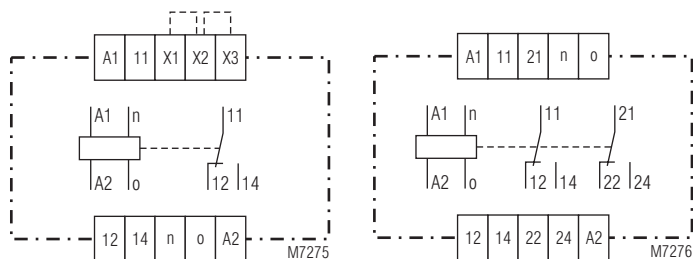

BA 9837.11,
AA 9837.11, AA 9838.11

BA 9837.12,
AA 9837.12

Connection Terminals

Terminal designation	Signal description
A1	+ / L
A2	- / N
n, o	Measuring input
X1, X3	Control input
X2	Control output
11, 12, 14, 21, 22, 24	Changeover contacts

Technical Data

Input

Measuring input: AC Amplitude AC 8 ... 500 V r.m.s
internal resistance: > 400 k Ω

Setting range:
BA 9837, AA 9837: 5 ... 15 Hz 40 ... 120 Hz
10 ... 30 Hz 100 ... 300 Hz
20 ... 60 Hz 200 ... 600 Hz
30 ... 90 Hz

AA 9838: 20 ... 80 Hz
Setting: Infinite on absolute scale
Response value: \geq setting value

Hysteresis:
BA 9837, AA 9837: 0.8 ... 0.97 of response value

AA 9838: 0.96 of response value

Accuracy: $< \pm 1 \%$

Temperature influence: $< \pm 0.15 \%$ / $^{\circ}\text{C}$

Influence of auxiliary supply: $< \pm 0.5 \%$ at 0.8 ... 1.1 U_N

Auxiliary Circuit

Auxiliary voltage U_H :
BA 9837: AC 24, 42, 110, 127, 230, 240 V

AA 9837: AC 42, 48, 110, 230 V

AA 9838: AC 48, 110, 230 V

Voltage range of U_H : 0.8 ... 1.1 U_H

Nominal consumption U_H : $< 3 \text{ VA}$

Nominal frequency of U_H : 50 / 60 Hz $\pm 5 \%$

Output

Contacts

BA 9837.11, AA 9837.11,
AA 9838.11:

1 changeover contact

BA 9837.12, AA 9837.12:

2 changeover contacts

Switching delay:

Setting range (Hz)	Bridge X1-X2	Bridge X2-X3
5 - 15	500 - 800	650 - 1 000
10 - 30	250 - 300	600 - 800
20 - 60	120 - 150	300 - 430
20 - 80	100 - 120	290 - 430
30 - 90	90 - 120	280 - 400
40 - 120	60 - 80	140 - 210
100 - 300	25 - 45	70 - 120
200 - 600	15 - 25	70 - 100

switching delay in ms

Technical Data

Thermal current I_{th}:	6 A	
Switching capacity		IEC/EN 60947-5-1
To AC 15, AC 230 V:	3 A / AC 230 V	
Electrical life		IEC/EN 60947-5-1
To AC 15, at 3 A, AC 230 V:	2.5×10^5 switching cycles	
Short circuit strength		
max. fuse rating:	4 A gG / gL	IEC/EN 60947-5-1
Mechanical life:	$> 30 \times 10^6$ switching cycles	

General Data

Operating mode:	Continuous operation
Temperature range:	
Operation:	- 20 ... + 60 $^{\circ}\text{C}$
Storage:	- 20 ... + 70 $^{\circ}\text{C}$
Altitude:	$\leq 2000 \text{ m}$

Clearance and creepage distances

Rated impulse voltage / pollution degree: 4 kV / 2 IEC 60664-1

EMC

Electrostatic discharge: 8 kV (air) IEC/EN 61000-4-2

HF-irradiation

80 MHz ... 2,7 GHz: 10 V / m IEC/EN 61000-4-3

Fast transients: 2 kV IEC/EN 61000-4-4

Surge voltages

Between

wires for power supply: 2 kV IEC/EN 61000-4-5

Between wire and ground: 4 kV IEC/EN 61000-4-5

HF wire guided: 10 V IEC/EN 61000-4-6

Interference suppression: Limit value class B EN 55011

Degree of protection

Housing: IP 40 IEC/EN 60529

Terminals: IP 20 IEC/EN 60529

Housing: Thermoplastic with V0 behaviour according to UL subject 94

Vibration resistance: Amplitude 0.35 mm,

frequency 10 ... 55 Hz, IEC/EN 60068-2-6

20 / 060 / 04 IEC/EN 60068-1

Terminal designation: EN 50005

Wire connection: 2 x 2.5 mm² solid or

2 x 1.5 mm² stranded wire with sleeve

DIN 46228-1/-2/-3/-4

Wire fixing: Flat terminals with self-lifting

clamping piece IEC/EN 60999-1

10 mm

Stripping length:

Screw mounting

AA 9837, AA 9838: 35 x 50 mm and

35 x 60 mm

Fixing torque: 0.8 Nm

Mounting: DIN rail IEC/EN 60715

Weight: 250 g

Dimensions

Width x height x depth:	45 x 77 x 127 mm
--------------------------------	------------------

Standard Type

BA 9837.11	30 / 90 Hz	AC 230 V	AC 50 / 60 HZ
Article number:	0050216		
• Output:	1 changeover contact		
• Measuring frequency:	30 / 90 Hz		
• Auxiliary voltage U_H :	230 V		
• Width:	45 mm		

Variants

	Frequency relay with 2 changeover contacts and internal bridges (X1, X2, X3)
BA 9837.12/010:	With internal bridge X1 - X2
BA 9837.12/020:	With internal bridge X2 - X3
AA 9837.12/010:	With internal bridge X1 - X2
AA 9837.12/020:	With internal bridge X2 - X3

Ordering example for variants

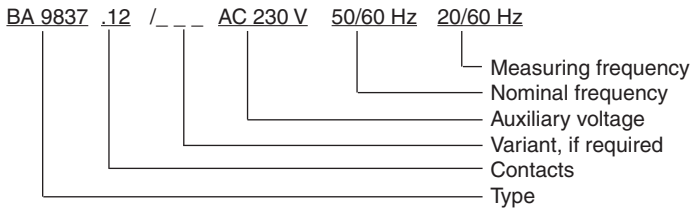

Accessories

IK 5110:	Series resistor for higher measuring voltage AC 12 ... 800 V eff. Article number: 0015751
----------	--

Characteristics

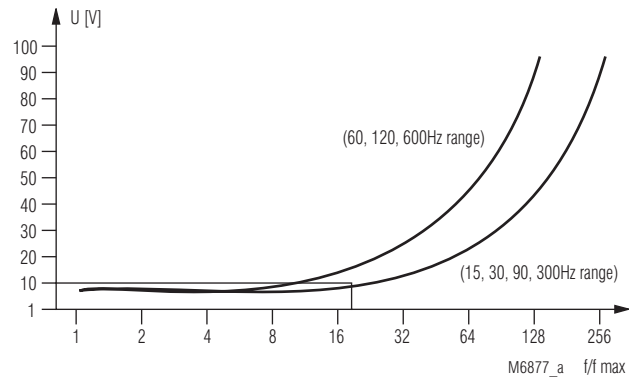

Measuring sensitivity

The diagram shows the sensitivity of the input of the frequency relay AA 9837. If the measuring voltage is lower than the curve values the frequency cannot be measured anymore. Please note.

Superimposed interference voltages on the measuring input with a ration.

$$\frac{f}{f_{\max}}$$

Above the curve values can influence the measuring results.

f - Frequency on input

f_{max} - Highest value of the actual frequency range

Example:

U_{meß}: 10 V; measuring frequency: f = 4 800 Hz

Chosen frequency range: 100 - 300 Hz, f_{max} = 300 Hz

$$\frac{f}{f_{\max}} = \frac{4\,800\text{ Hz}}{300\text{ Hz}} = 16$$

The measuring frequency is detected, as the measuring voltage is above the response curve.

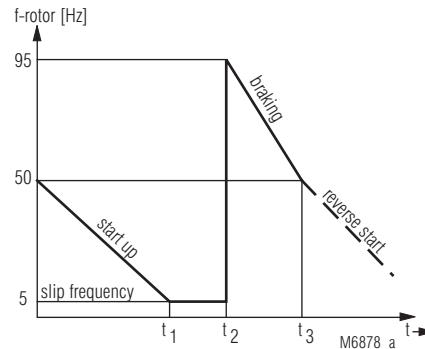

t₁ nominal speed reached

t₂ start braking

t₃ standstill (end of braking to avoid reverse start)

Rotor frequency at countercurrent braking

Braking:

When reversing the phases for braking the rotor frequency changes and drops proportional to the speed to mains frequency. E.g. when the rotor frequency is 5 Hz at nominal speed, it to 95 Hz. When the motor is at stand still the rotor frequency is nominal frequency. At this point the frequency relay has to give the signal to stop braking, before the motor starts up in the opposite direction.

Connection Example

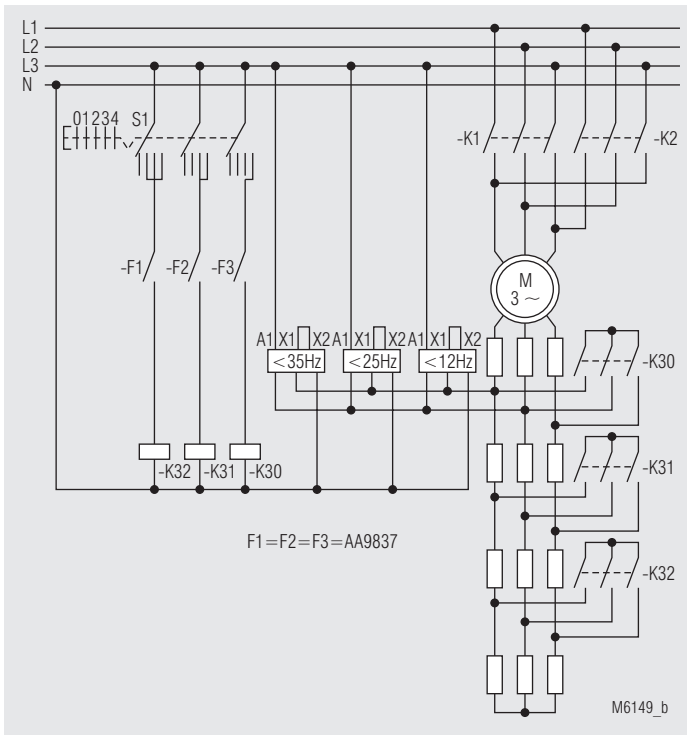

Motor control with starting resistance

Start:

To achieve an optimum speed depending starting inertia, different starting resistors are switched into the rotor circuit, when certain speed values are reached. Often this procedure is controlled with timers, but with small loads the motor reaches the speed to switch over much faster than with high loads and the motor still runs on the lower stage. When the switching of the resistors is controlled speed depending by frequency relays, the start up cycles can be shortened and the plant can be used more effective.